

2026 Boulder Valley Riders 4-H and Open Show Showmanship L3-4

Show Date: 06-20-2026

w w w . H o r s e S h o w P a t t e r n s . c o m

w w w . H o r s e S h o w P a t t e r n s . c o m

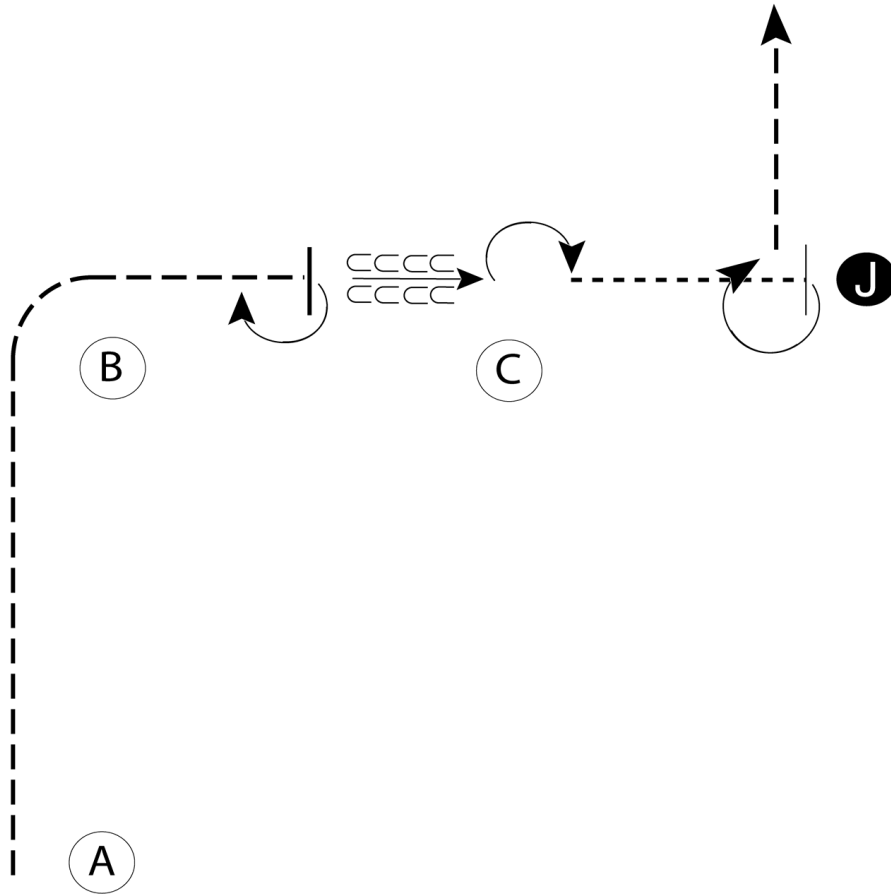

1. Jog from A around B
2. Half way to C stop and perform a 180 degree turn
3. Back to C
4. Perform a 180 degree turn, walk to Judge and set up for inspection
5. When dismissed perform a 270 degree turn and trot to lineup

- Walk -----
- Trot - - - - -
- Back ←
- Marker (B)
- Judge (J)

[S/2-26]

Pattern Provided by:
BVR

2026 Boulder Valley Riders 4-H and Open Show Showmanship L2

Show Date: 06-20-2026

w w w . H o r s e S h o w P a t t e r n s . c o m

w w w . H o r s e S h o w P a t t e r n s . c o m

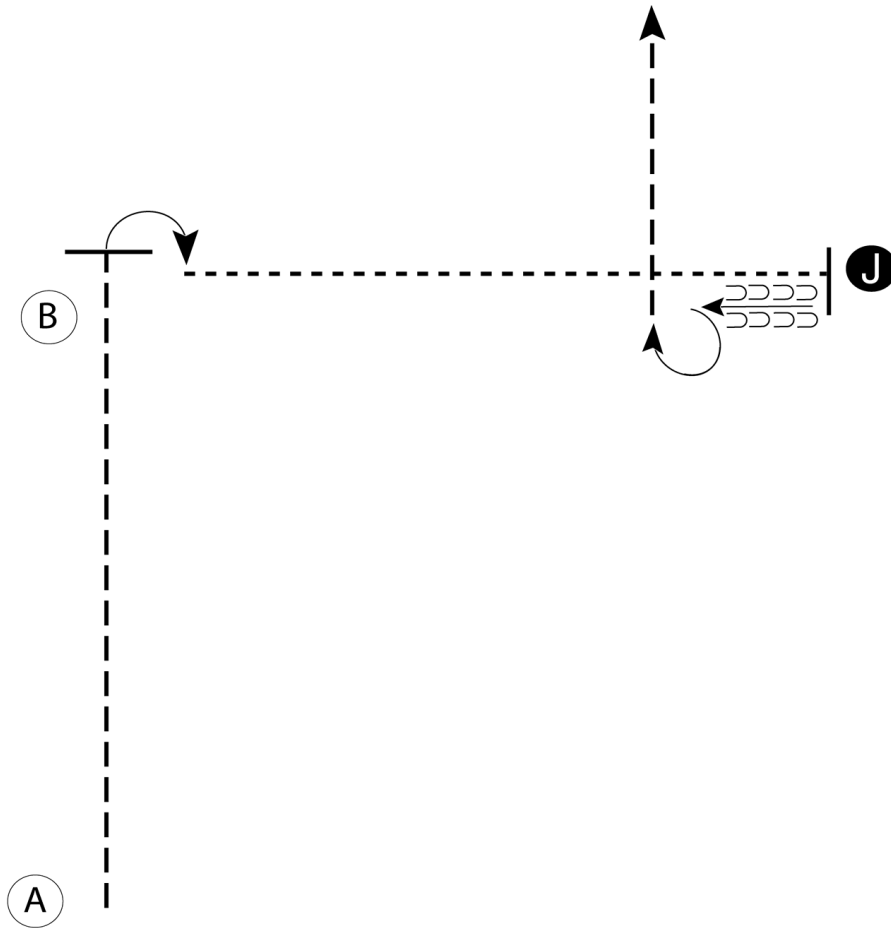

1. Begin at A. Trot from A past B
2. Stop and perform a 90 degree turn
3. Walk to the Judge, stop and set up for inspection
4. When dismissed back one horse length and perform a 270 degree turn
5. Trot to the line-up

Walk	-----
Trot	- - - - -
Back	← 
Marker	ⓑ
Judge	ⓐ

[S/1-14]

Pattern Provided by:
BVR

2026 Boulder Valley Riders 4-H and Open Show Showmanship L1

Show Date: 06-20-2026

w w w . H o r s e S h o w P a t t e r n s . c o m

w w w . H o r s e S h o w P a t t e r n s . c o m

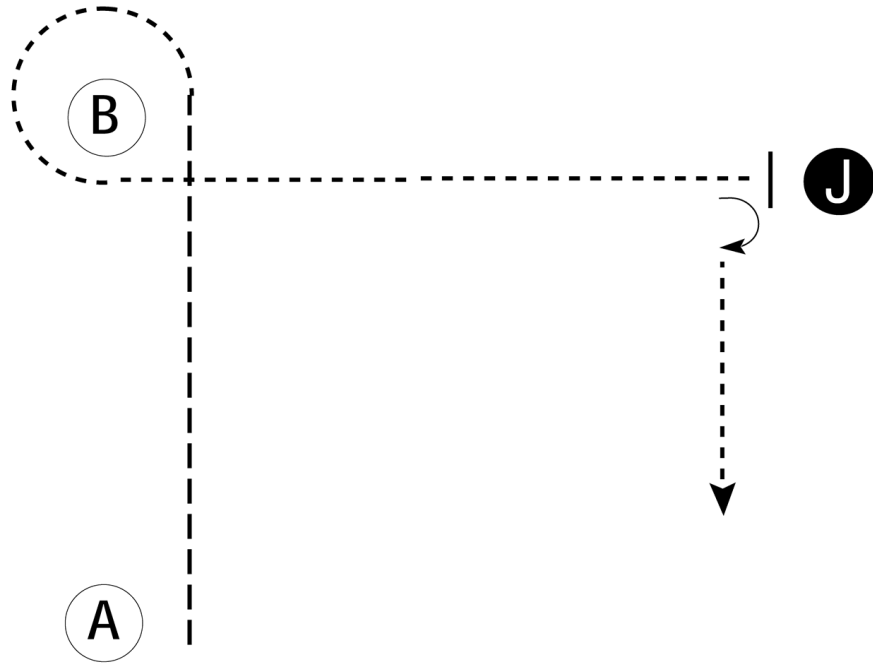

Be ready at A.

1. Trot from A to B.
2. Walk a tight circle around B.
3. Walk to judge.
4. Stop and set up for inspection.
5. When dismissed, perform a 90 degree turn and walk away.

Follow the directions of your ring steward.

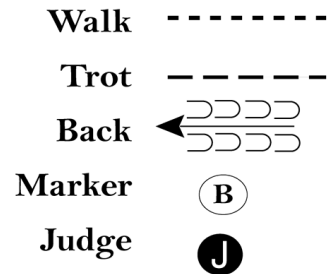

[S/1-56]

Pattern Provided by:
BVR

2026 Boulder Valley Riders 4-H and Open Show

Showmanship Unrated AND Parents

Show Date: 06-20-2026

w w w . H o r s e S h o w P a t t e r n s . c o m

w w w . H o r s e S h o w P a t t e r n s . c o m

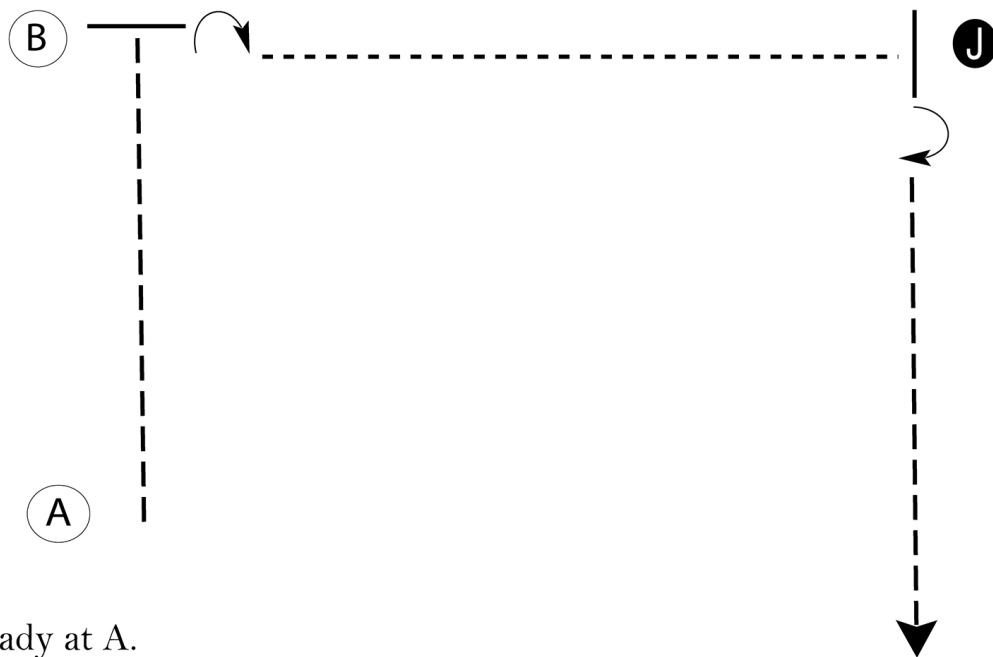

Be ready at A.

1. Trot to B and stop.
2. Perform a 90 degree turn. Walk to judge.
3. Stop, set up, inspection.
4. When dismissed, perform a 90 degree turn.
5. Trot to the line up or follow the directions of the ring steward.

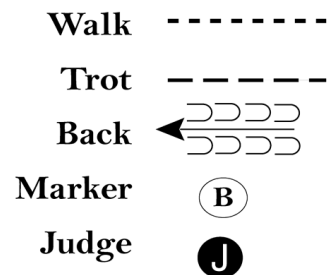

[S/WT-29]

Pattern Provided by:

BVR

2026 Boulder Valley Riders 4-H and Open Show Showmanship Open

Show Date: 06-20-2026

w w w . H o r s e S h o w P a t t e r n s . c o m

w w w . H o r s e S h o w P a t t e r n s . c o m

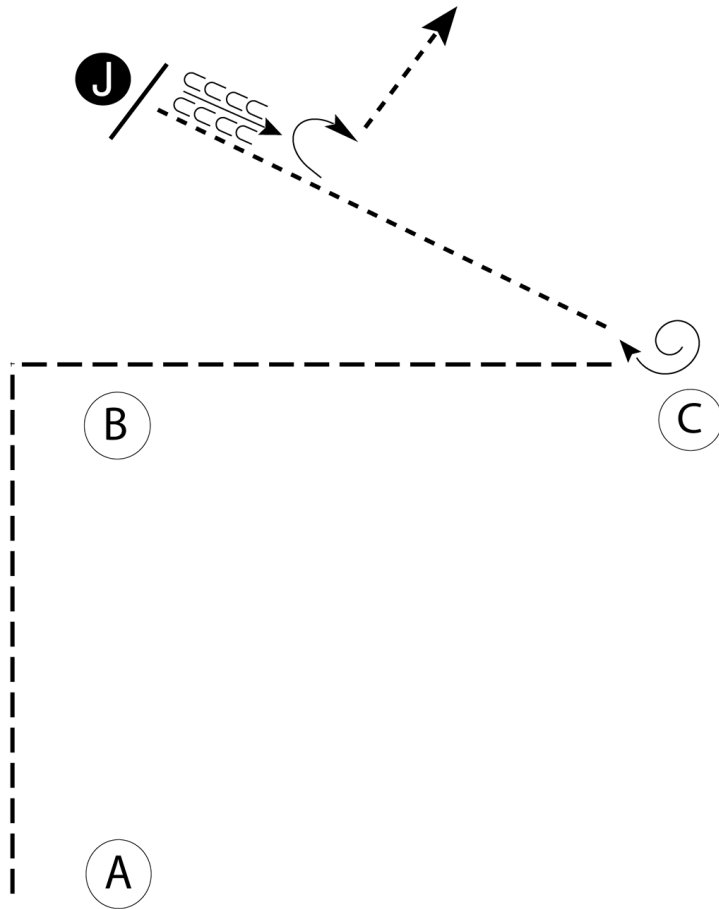

Be ready at A.

1. Trot to B.
2. Trot the corner at B and continue to trot to C.
3. Stop at C.
4. 1 5/8 turn at C.
5. Walk to judge and set up for inspection.
6. When dismissed, back one horse length.
7. 1/4 turn and walk off.

Walk	-----
Trot	- - - - -
Back	←
Marker	⊙ B
Judge	● J

[S/2-20]

Pattern Provided by:
BVR

2026 Boulder Valley Riders 4-H and Open Show English Equitation L3/4

Show Date: 06-20-2026

w w w . H o r s e S h o w P a t t e r n s . c o m

w w w . H o r s e S h o w P a t t e r n s . c o m

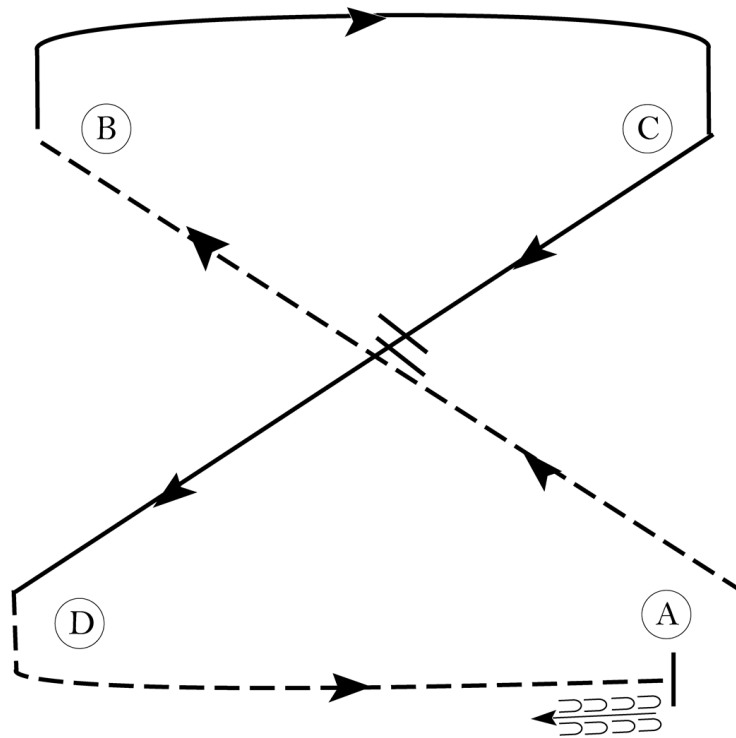

Be ready at A.

1. Posting trot on the left diagonal to B.
2. Canter on the right lead to and around C and 1/2 way to D.
3. Change leads and canter to D.
4. Posting trot on the right diagonal to A.
5. Halt at A and back approximately one horse length.

Exit at a sitting trot.

Walk	-----
Trot	- - - - -
Extended Trot	— — — — —
Canter	—————
Leg Yield	
Lead Change	— / —
Back	← ← ← ← ←
Marker	Ⓚ
Sidepass	← - - - - ←
Hand Gallop	— — — — —

[HSE/2-24]

Pattern Provided by:
BVR

2026 Boulder Valley Riders 4-H and Open Show English Equitation L2

Show Date: 06-20-2026

w w w . H o r s e S h o w P a t t e r n s . c o m

w w w . H o r s e S h o w P a t t e r n s . c o m

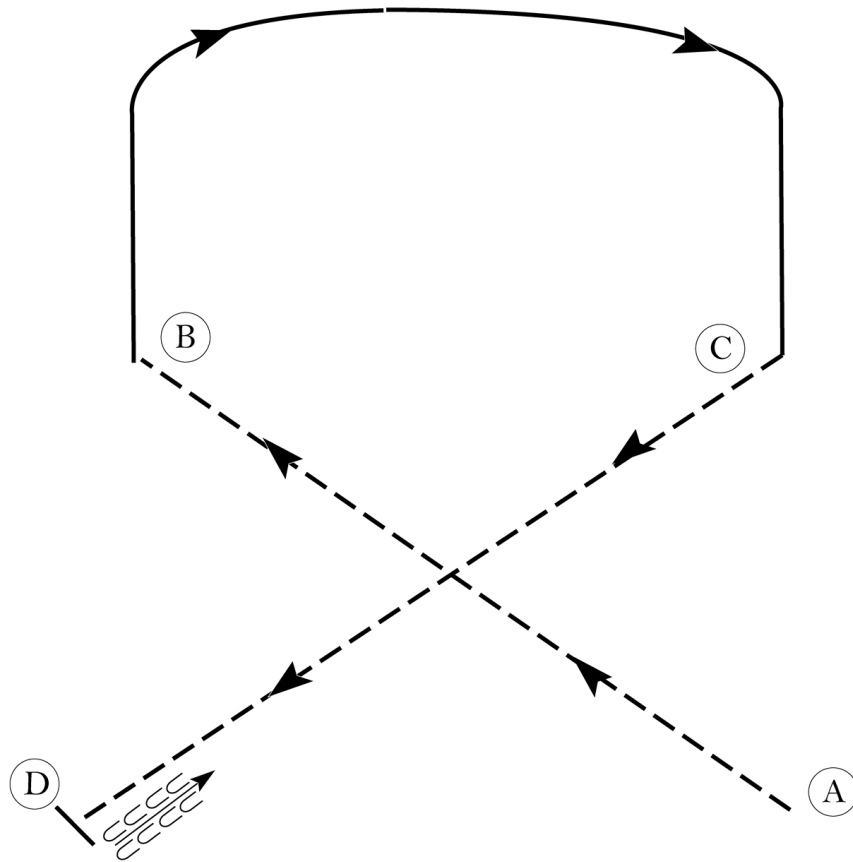

Be ready at A.

1. Posting trot on the left diagonal to B.
2. Canter right lead to C.
3. Posting trot on the right diagonal 1/2 way to D.
4. Sitting trot to D.
5. Halt at D and back approximately one horse length.

Exit at a sitting trot.

Walk	-----
Trot	- - - - -
Extended Trot	— — — — —
Canter	—————
Leg Yield	
Lead Change	— / —
Back	← ← ← ← ←
Marker	(B)
Sidepass	← ← ← ← ←
Hand Gallop	— — — — —

[HSE/1-23]

Pattern Provided by:
BVR

2026 Boulder Valley Riders 4-H and Open Show English Equitation L1

Show Date: 06-20-2026

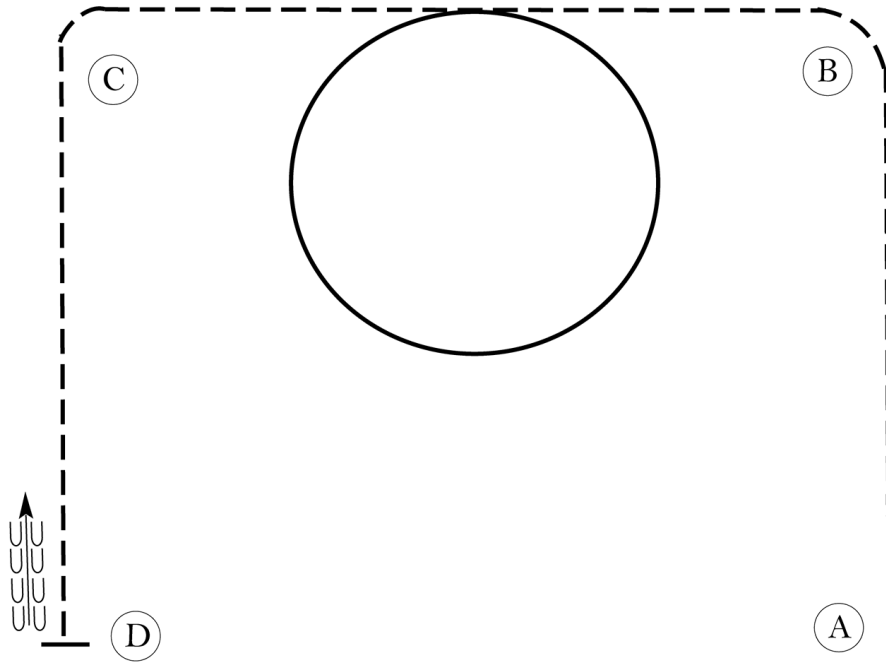

Be ready at A.

1. Walk two horse lengths from A.
2. Posting trot on the right diagonal to and around B and halfway to C.
3. Halfway to C, canter a circle to the left.
4. Close the circle and trot on the right diagonal to C.
5. Change diagonals and trot on the left diagonal to D.
6. Halt at D and back approximately one horse length.

Follow the instructions of your ring steward.

Walk	-----
Trot	- - - - -
Extended Trot	-----
Canter	-----
Leg Yield	
Lead Change	↙ ↘
Back	← ← ← ← ←
Marker	⊙
Sidepass	← - - - - →
Hand Gallop	-----

[HSE/1-62]

Pattern Provided by:

BVR

2026 Boulder Valley Riders 4-H and Open Show English Equitation Open

Show Date: 06-20-2026

w w w . H o r s e S h o w P a t t e r n s . c o m

w w w . H o r s e S h o w P a t t e r n s . c o m

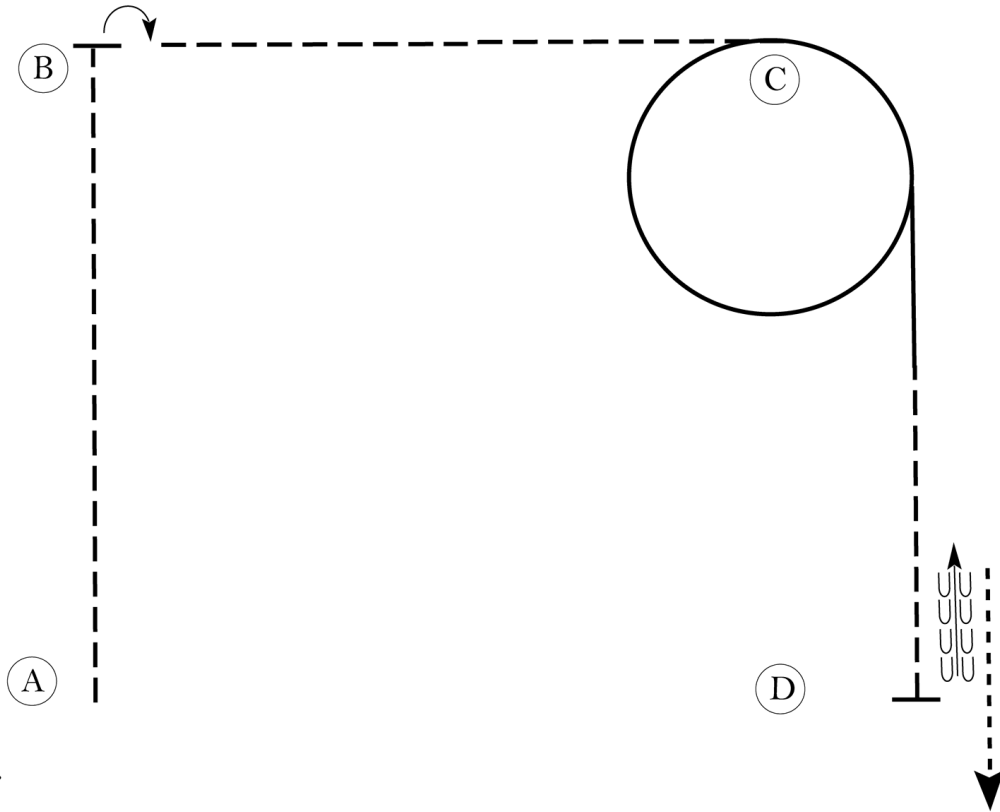

Be ready at A.

1. Sitting trot to B.
2. Stop at B and execute a 90 degree turn on the haunches to the right.
3. Posting trot on the right diagonal to C.
4. Canter on the right lead in a circle around C.
5. Continue on the right lead halfway to D.
6. Posting trot on the left diagonal to D.
7. Stop at D and back approximately one horse length.
8. Walk forward to and past D.

Follow the instructions of your ring steward.

Walk	-----
Trot	- - - - -
Extended Trot	-----
Canter	=====
Leg Yield	
Lead Change	↙ ↘
Back	← ← ← ← ←
Marker	⊥
Sidepass	← - - - - →
Hand Gallop	=====

[HSE/1-43]

Pattern Provided by:
BVR

2026 Boulder Valley Riders 4-H and Open Show

Showmanship Miniature Horse

Show Date: 06-20-2026

w w w . H o r s e S h o w P a t t e r n s . c o m

w w w . H o r s e S h o w P a t t e r n s . c o m

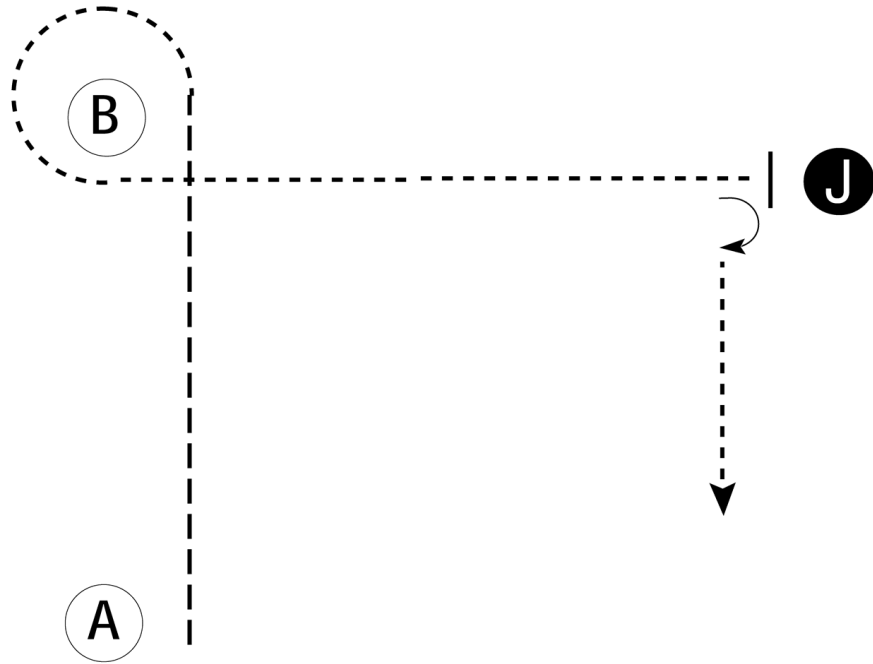

Be ready at A.

1. Trot from A to B.
2. Walk a tight circle around B.
3. Walk to judge.
4. Stop and set up for inspection.
5. When dismissed, perform a 90 degree turn and walk away.

Follow the directions of your ring steward.

- Walk -----
- Trot - . - . - .
- Back ← — — — — —
— — — — —
- Marker ○ B
- Judge ● J

[S/1-56]

Pattern Provided by:
BVR

2026 Boulder Valley Riders 4-H and Open Show Stick Horse

Show Date: 06-20-2026

w w w . H o r s e S h o w P a t t e r n s . c o m

w w w . H o r s e S h o w P a t t e r n s . c o m

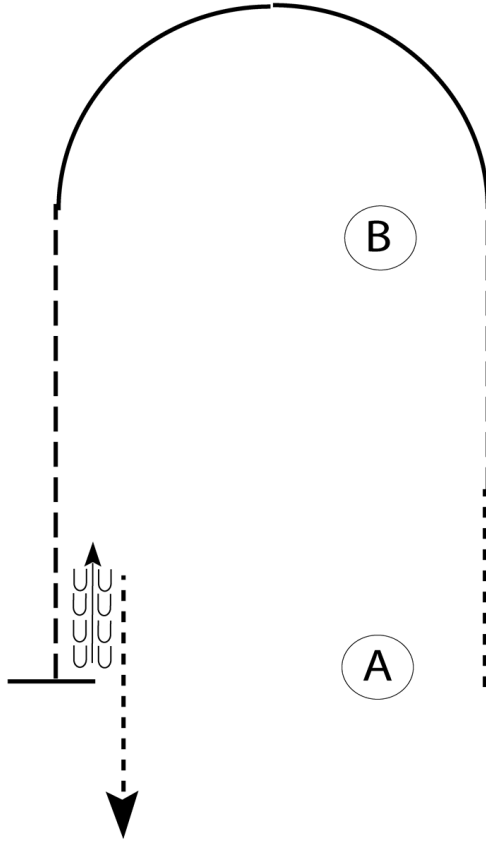

Be ready at A.

1. When acknowledged, walk two horse lengths from A.
2. Jog to B.
3. Lope on the left lead in a half circle until even with B.
4. Jog until even with A.
5. Stop even with A and back approximately one horse length.
6. Exit pattern at a walk.

Follow the instructions of your ring steward.

Walk
Jog	-----
Extended Jog	-----
Lope	—————
Lead Change	———/———
Back	← U U U U
Marker	ⓑ

[WH/1-83]

Pattern Provided by:

BVR

2026 Boulder Valley Riders 4-H and Open Show Western Horsemanship L3/4

Show Date: 06-20-2026

www.HorseShowPatterns.com

www.HorseShowPatterns.com

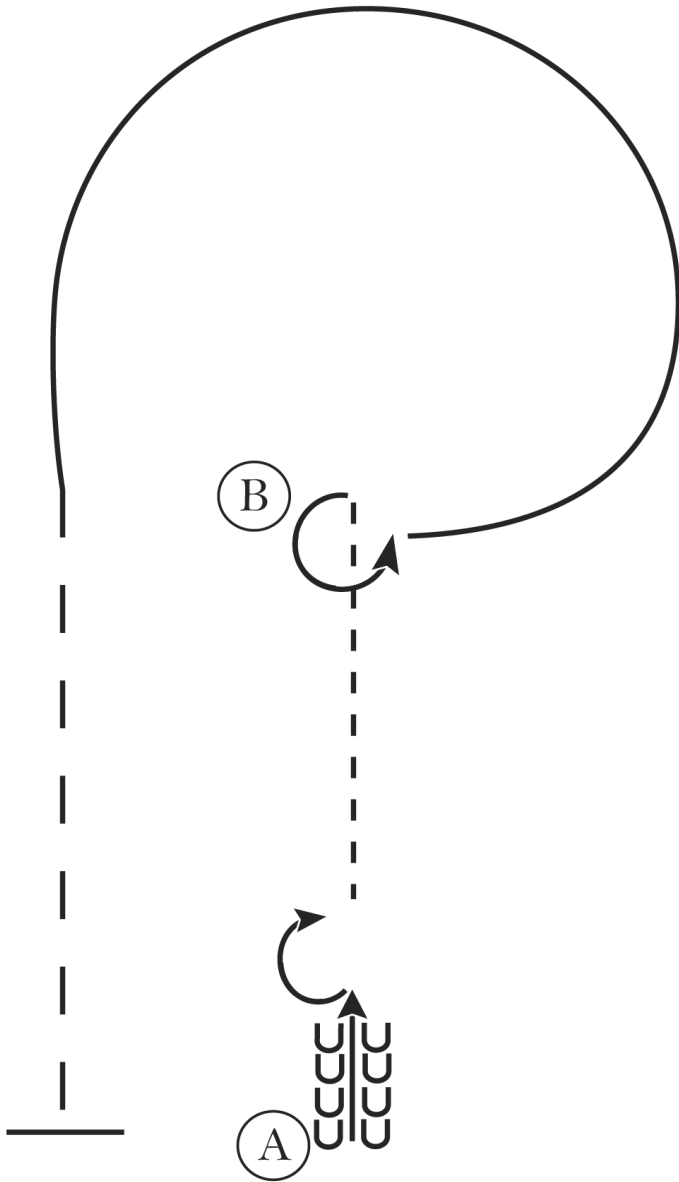

1. Back 4 steps at A.
2. Perform a 180 degree turn to the right.
3. Jog to B.
4. At B perform a 270 degree turn to the left .
5. Lope a circle around B on the left lead.
6. At B extend the jog to A.
7. At A stop.

Walk
Jog	-----
Extended Jog	-----
Lope	—————
Leg Yield	
Lead Change	↙↘
Back	←←← ←←←
Marker	Ⓚ
Sidepass	←←←

[WH/2-8]

Pattern Provided by:

BVR

2026 Boulder Valley Riders 4-H and Open Show

Western Horsemanship L2 and Open

Show Date: 06-20-2026

w w w . H o r s e S h o w P a t t e r n s . c o m

w w w . H o r s e S h o w P a t t e r n s . c o m

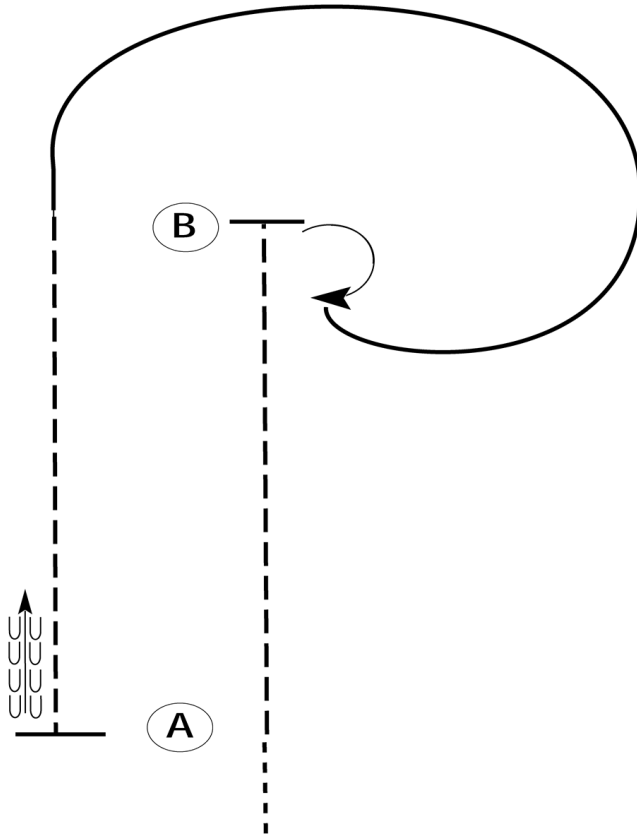

Be ready before A.

1. Walk to A.
2. Jog to B.
3. Turn 180 degrees to the right.
4. Lope on the left lead back around to B.
5. Jog from B to A.
6. Stop at A and back approximately one horse length.

Follow the instructions of your ring steward.

Walk	-----
Jog	- - - - -
Extended Jog	— — — —
Lope	—————
Leg Yield	
Lead Change	— / —
Back	← — — — — — — — — ←
Marker	⊙
Sidepass	← — — — — →

[WH/1-44]

Pattern Provided by:
BVR

2026 Boulder Valley Riders 4-H and Open Show

Western Horsemanship Level 1

Show Date: 06-20-2026

w w w . H o r s e S h o w P a t t e r n s . c o m

w w w . H o r s e S h o w P a t t e r n s . c o m

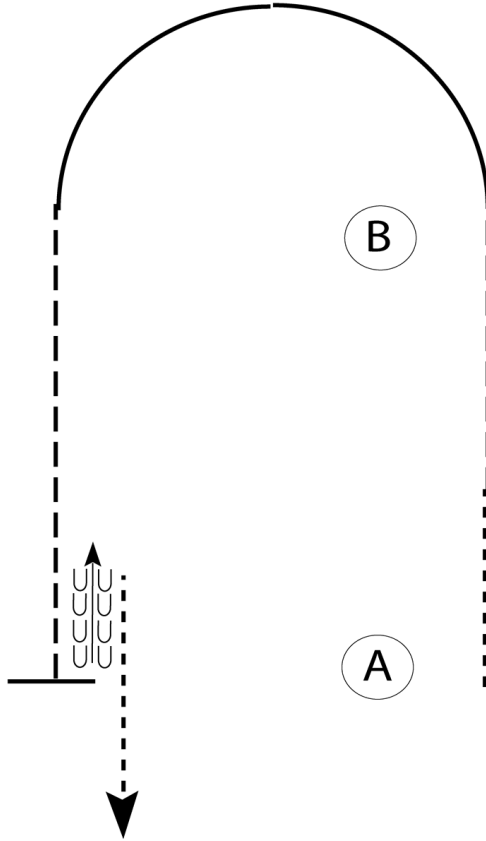

Be ready at A.

1. When acknowledged, walk two horse lengths from A.
2. Jog to B.
3. Lope on the left lead in a half circle until even with B.
4. Jog until even with A.
5. Stop even with A and back approximately one horse length.
6. Exit pattern at a walk.

Follow the instructions of your ring steward.

Walk	-----
Jog	- - - - -
Extended Jog	— — — —
Lope	—————
Lead Change	
Back	
Marker	(B)

[WH/1-83]

Pattern Provided by:
BVR