

2026 BVR Schooling Show

Class 1 Showmanship 4+ Years Showing

Show Date: 04-25-2026

w w w . H o r s e S h o w P a t t e r n s . c o m

w w w . H o r s e S h o w P a t t e r n s . c o m

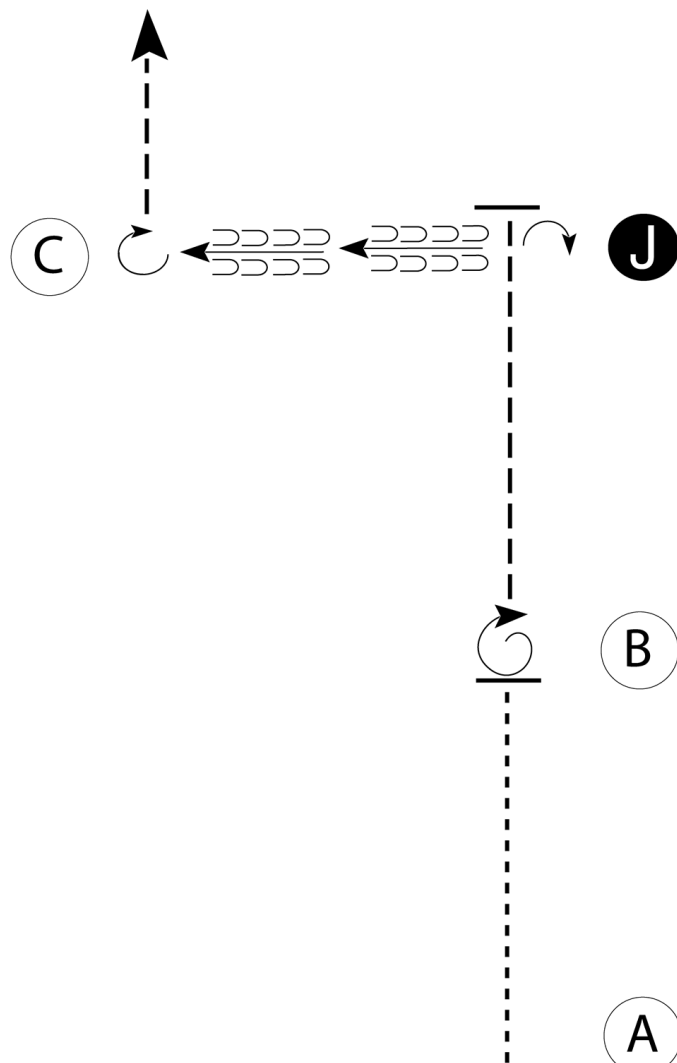

Be ready at A.

1. Walk A to B.
2. Stop at B and perform a 360 degree turn.
3. Trot until even with Judge.
4. Stop and perform a 90 degree turn; set up for inspection.
5. When dismissed, back to C.
6. Perform a 270 degree turn and trot straight away.

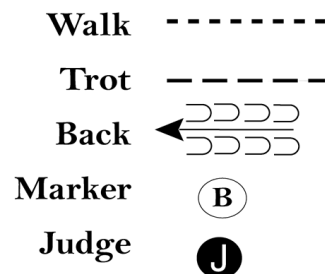

Follow the instructions of your ring steward.

[S/2-4]

Pattern Provided by:

Emily Southard

2026 BVR Schooling Show

Class 2 Showmanship 0-3 Years

Show Date: 04-25-2026

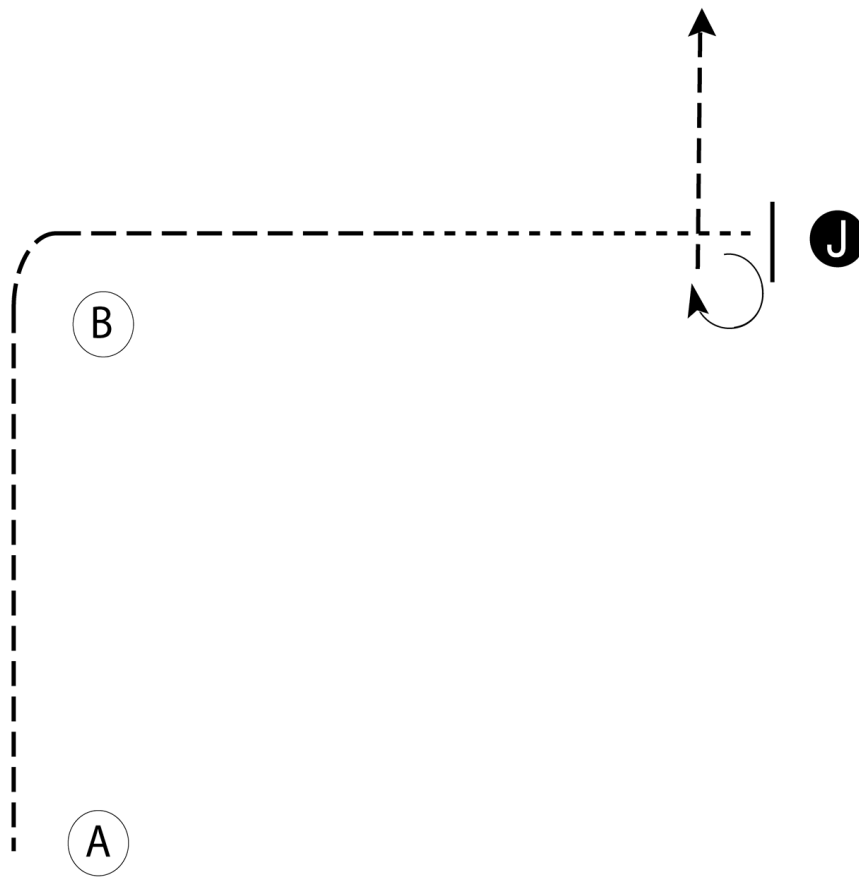

Be ready at A.

1. Trot from A around B and half way to the Judge.
2. Break to the walk.
3. Walk to the Judge and set up for inspection.
4. When dismissed, perform a 270 degree turn and trot straight away from the Judge.

Follow the instructions of your ring steward.

Walk	-----
Trot	- - - - -
Back	← 
Marker	Ⓟ
Judge	Ⓝ

[S/1-33]

Pattern Provided by:

Emily Southard

2026 BVR Schooling Show

Class 3 Parents Showmanship

Show Date: 04-25-2026

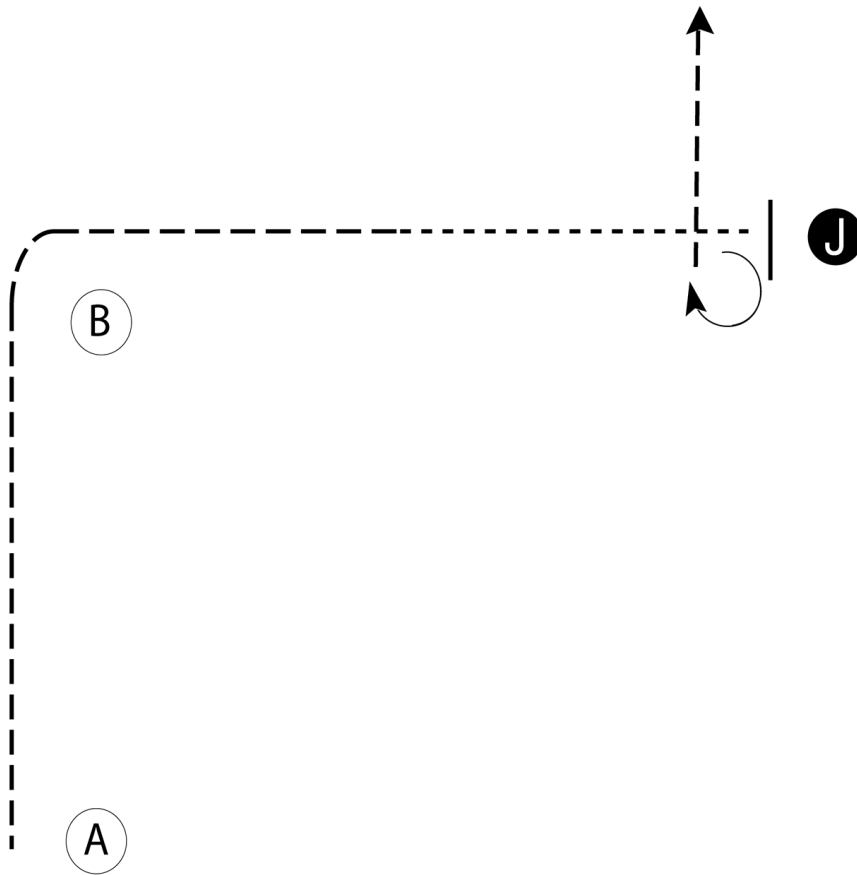

Be ready at A.

1. Trot from A around B and half way to the Judge.
2. Break to the walk.
3. Walk to the Judge and set up for inspection.
4. When dismissed, perform a 270 degree turn and trot straight away from the Judge.

Follow the instructions of your ring steward.

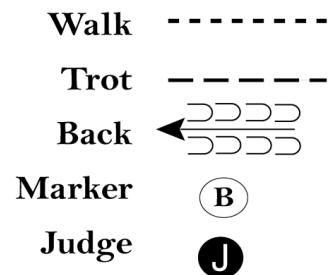

[S/1-33]

Pattern Provided by:

Emily Southard

w w w . H o r s e S h o w P a t t e r n s . c o m

w w w . H o r s e S h o w P a t t e r n s . c o m

2026 BVR Schooling Show

Class 6 English Equitation 4+ Years

Show Date: 04-25-2026

w w w . H o r s e S h o w P a t t e r n s . c o m

w w w . H o r s e S h o w P a t t e r n s . c o m

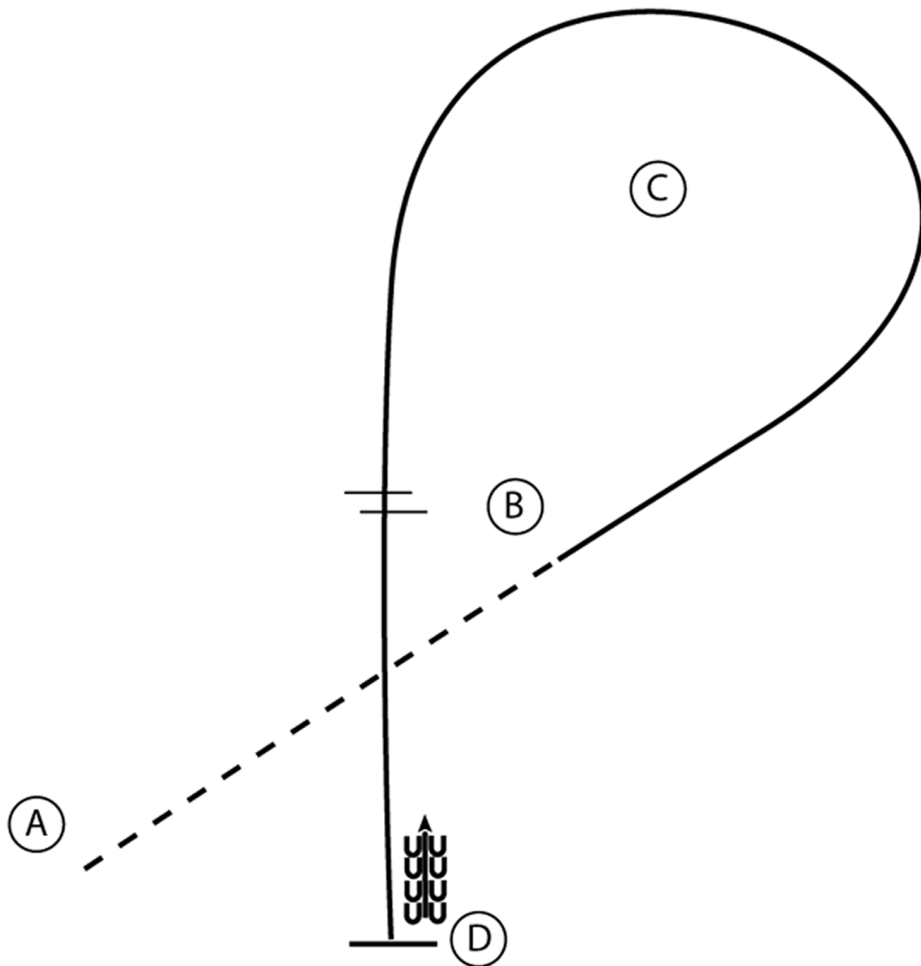

1. Posting trot, right diagonal, A to B
2. At B canter on the right lead around C to B
3. At B perform a simple lead change and continue to D
4. Stop at D and back approximately one horse length.

Walk
Trot	-----
Extended Trot	-----
Canter	—————
Leg Yield	
Lead Change	—/—
Back	← 3333
Marker	⊙ B
Sidepass	← - - - ←

[HSE/2-9]

Pattern Provided by:
Emily Southard

2026 BVR Schooling Show

Class 8 English Equitation 0-3 Years

Show Date: 04-25-2026

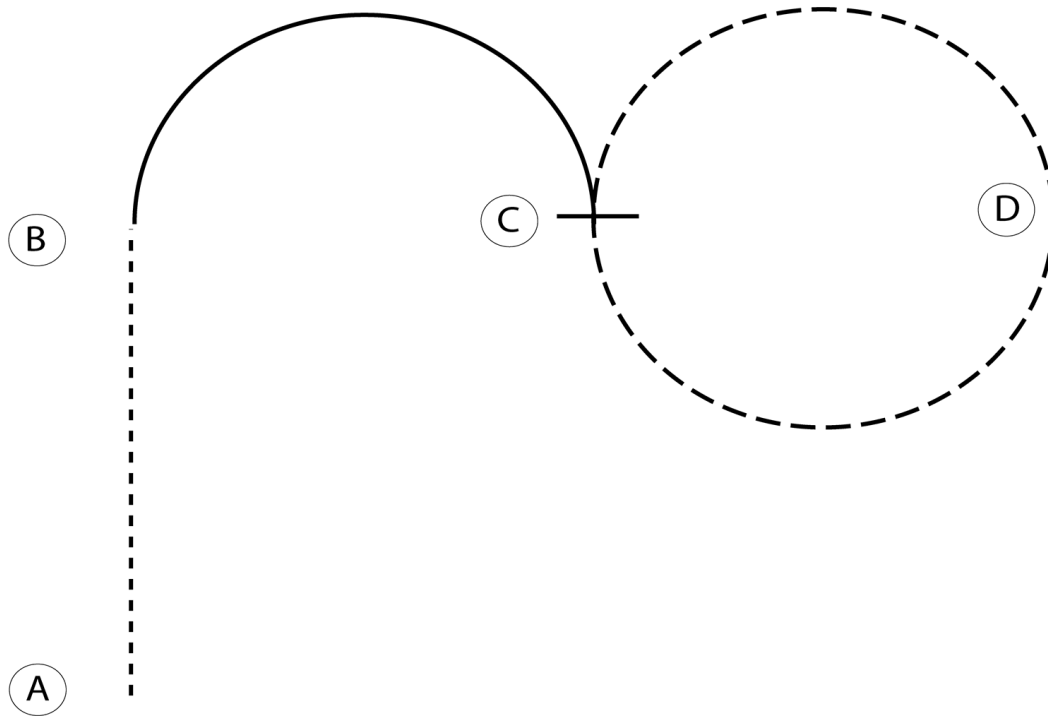

Be ready at A.

1. Walk from A to B.
2. At B, canter on the right lead in a half circle to C.
3. At C, posting trot to D.
4. Sitting trot from D to C.
5. Stop at C.

Follow the instructions of your ring steward.

Walk	-----
Trot	- - - - -
Extended Trot	-----
Canter	—————
Leg Yield	
Lead Change	↙ ↘
Back	← ← ← ← ←
Marker	⊙
Sidepass	← — — — — →
Hand Gallop	—————

[HSE/1-16]

Pattern Provided by:

Emily Southard

w w w . H o r s e S h o w P a t t e r n s . c o m

w w w . H o r s e S h o w P a t t e r n s . c o m

2026 BVR Schooling Show

Class 10 English Equitation Walk/Trot 0-3 Years

Show Date: 04-25-2026

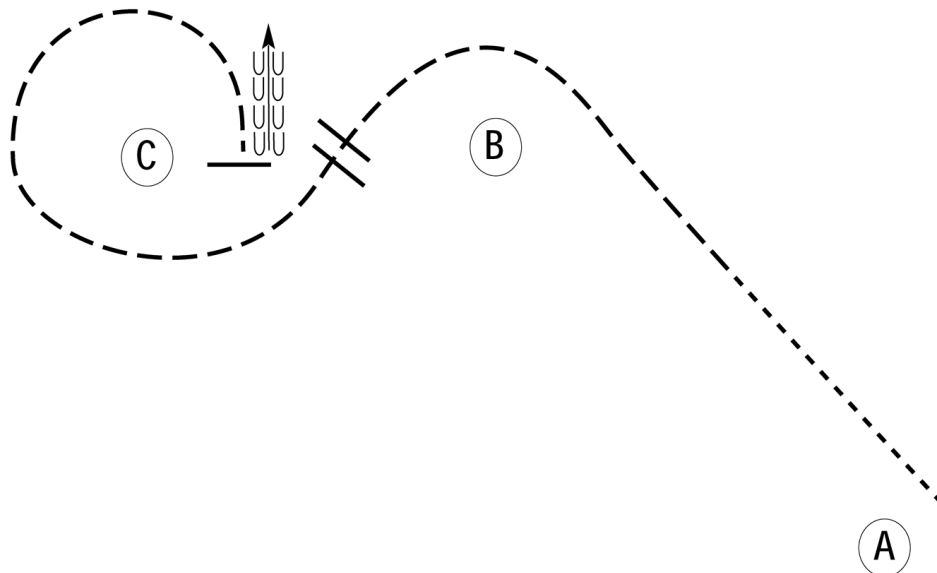

Be ready at A.

1. Walk halfway to B.
2. Posting trot on the right diagonal to and around B and halfway to C.
3. Change diagonals halfway to C.
4. Posting trot on the left diagonal to and around C.
5. Stop at C.
6. Back approximately one horse length.

Walk	-----
Trot	- - - - -
Extended Trot	-----
Canter	-----
Leg Yield	
Lead Change	
Back	←←←
Marker	⊙
Sidepass	←---→
Hand Gallop	-----

[HSE/WT-13]

Pattern Provided by:

Emily Southard

w w w . H o r s e S h o w P a t t e r n s . c o m

w w w . H o r s e S h o w P a t t e r n s . c o m

Class 12. English Control 4+ Years Showing

480. Pattern 2 – Level III and IV English Control

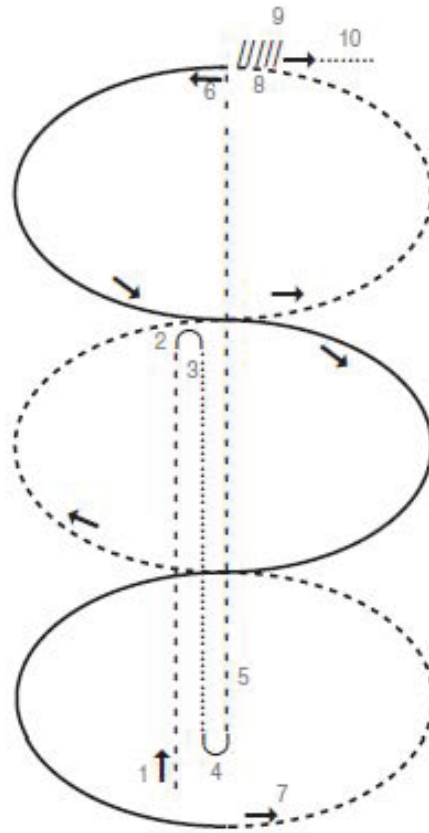

Walk: Canter: _____
Back: //////////////// Trot: - - - - -

1. Sitting trot.
2. Halt, half turn (180 degrees) right on haunches.
3. Normal walk.
4. Halt, half turn (180 degrees) left on haunches.
5. Lengthen trot rising.
6. Canter serpentine with appropriate changes of lead, simple or flying.
7. Rising trot serpentine with change of diagonals.
8. Halt.
9. Back.
10. Leave arena on a loose rein at the free walk.

Class 13. English Control 0-3 Years Showing

476. Pattern B – Level I English Control

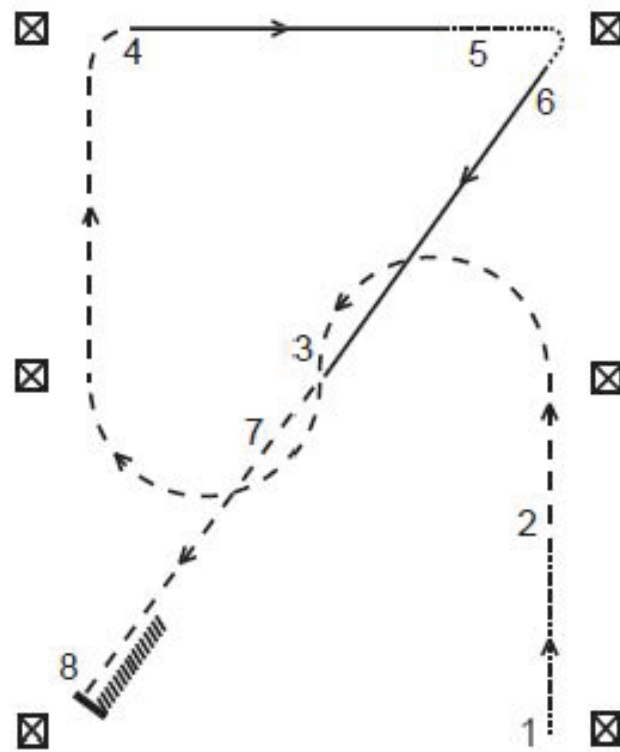

Walk: Canter: _____
Back: ////////////// Trot: - - - - -

1. Normal walk.
2. Rising trot halfway between cones.
3. Serpentine showing change of diagonal.
4. Canter right lead $\frac{3}{4}$ of the way across.
5. Before corner, walk.
6. Canter left lead to the center.
7. Sitting trot.
8. Halt, back.

Leave arena on a loose rein at the free walk.

2026 BVR Schooling Show

Class 14 Stick Horse

Show Date: 04-25-2026

w w w . H o r s e S h o w P a t t e r n s . c o m

w w w . H o r s e S h o w P a t t e r n s . c o m

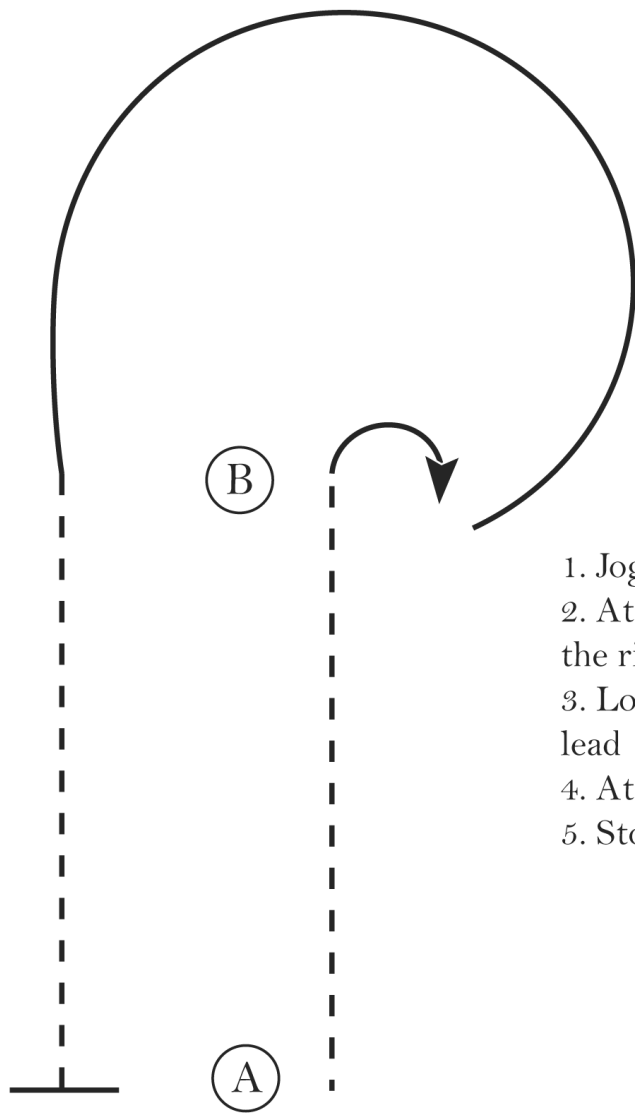

1. Jog A to B
2. At B perform a 90 degree turn to the right
3. Lope a circle around B on the left lead
4. At B jog to A
5. Stop at A.

Walk
Jog	- - - - -
Extended Jog	- - - - -
Lope	—————
Leg Yield	
Lead Change	↘
Back	←←←←← ←←←←←
Marker	⊙
Sidepass	←←←←←

[WH/1-14]

Pattern Provided by:
Emily Southard

2026 BVR Schooling Show

Class 15 Mini Showmanship

Show Date: 04-25-2026

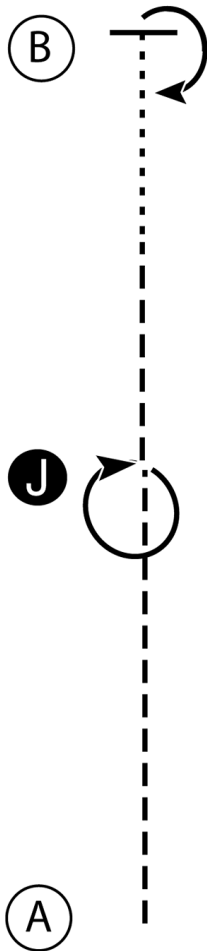

1. Trot from A to Judge.
2. Stop, perform a 360 degree turn and set up for inspection.
3. When dismissed trot half way to B, break to the walk and walk to B.
4. Stop at B, perform a 180 degree turn, and wait for instructions from the ring steward.

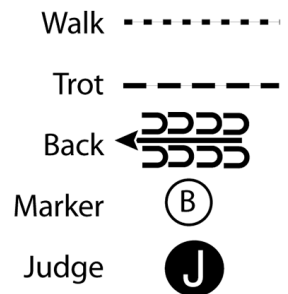

[S/1-9]

Pattern Provided by:
Emily Southard

www.HorseShowPatterns.com

www.HorseShowPatterns.com

2026 BVR Schooling Show

Class 16 Mini In-Hand Pattern

Show Date: 04-25-2026

w w w . H o r s e S h o w P a t t e r n s . c o m

w w w . H o r s e S h o w P a t t e r n s . c o m

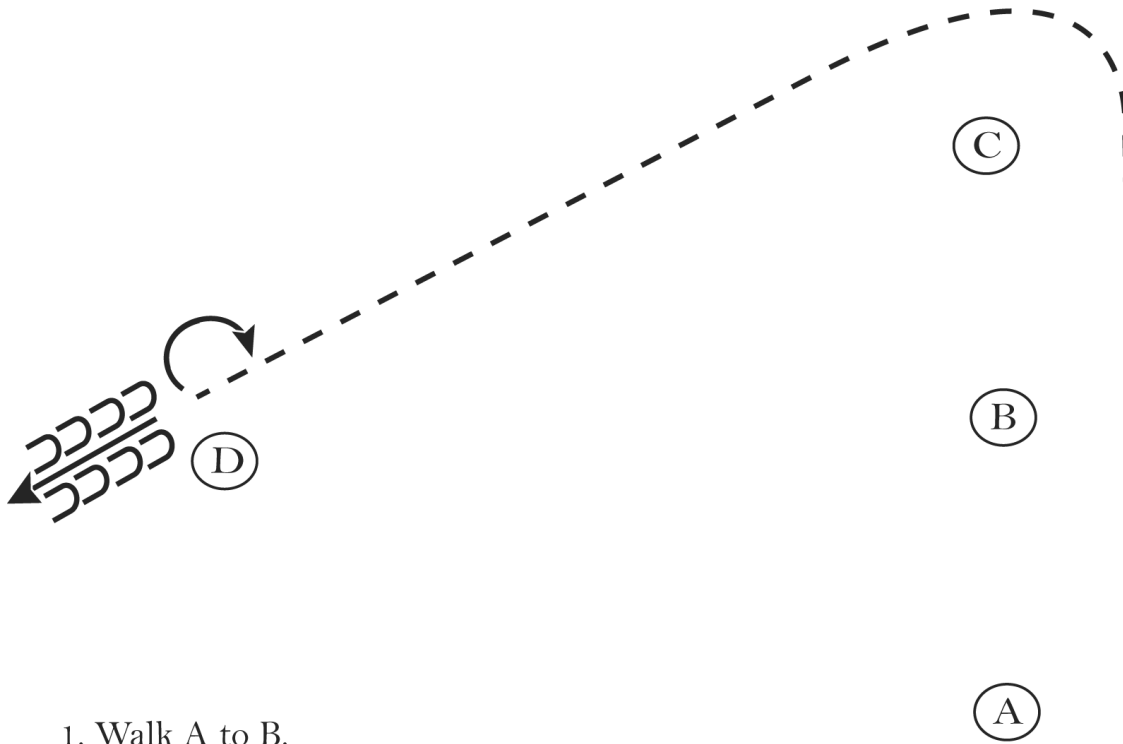

1. Walk A to B.
2. At B jog around C to D.
3. At D perform a 180 degree turn to the right.
4. Back 4 steps.

Walk
Jog	-----
Extended Jog	-----
Lope	—————
Leg Yield	
Lead Change	↘
Back	←←←←
Marker	(B)
Sidepass	←←←←

[WH/WT-10]

Pattern Provided by:

Emily Southard

Barrel Racing Pattern

Can do either direction first!

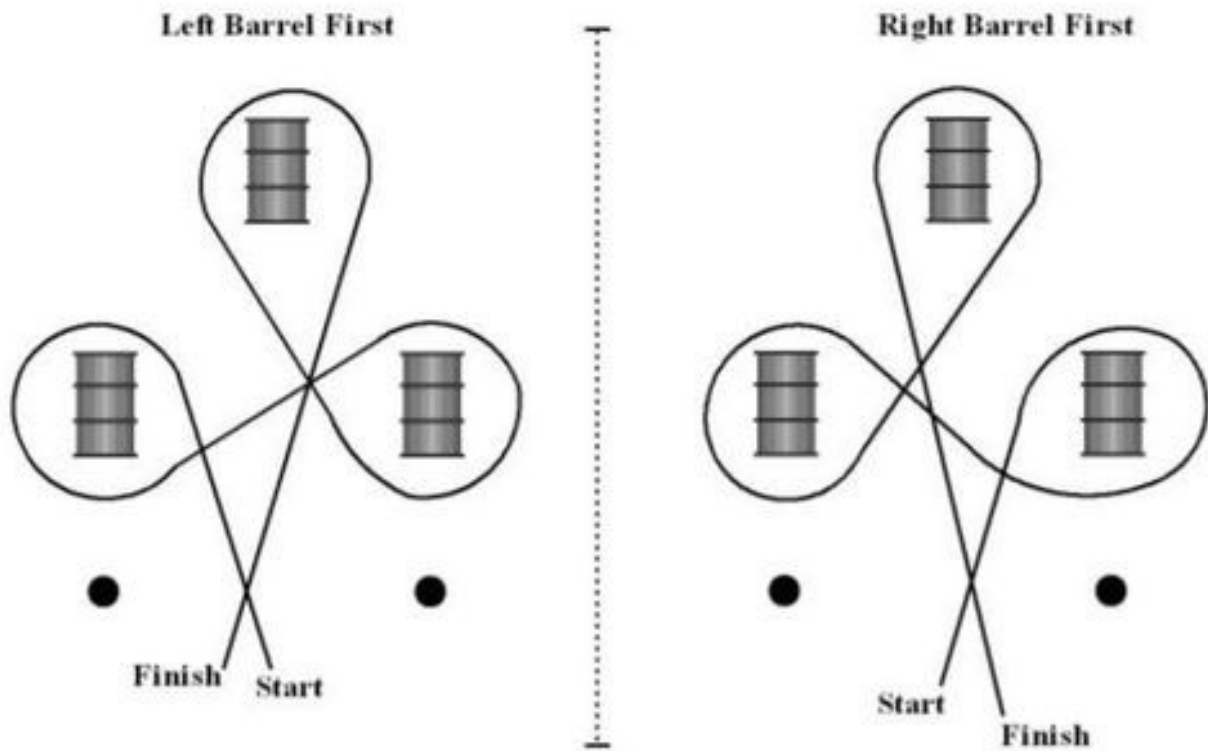

2026 BVR Schooling Show

Class 21 Western Equitation 4+ Years

Show Date: 04-25-2026

w w w . H o r s e S h o w P a t t e r n s . c o m

w w w . H o r s e S h o w P a t t e r n s . c o m

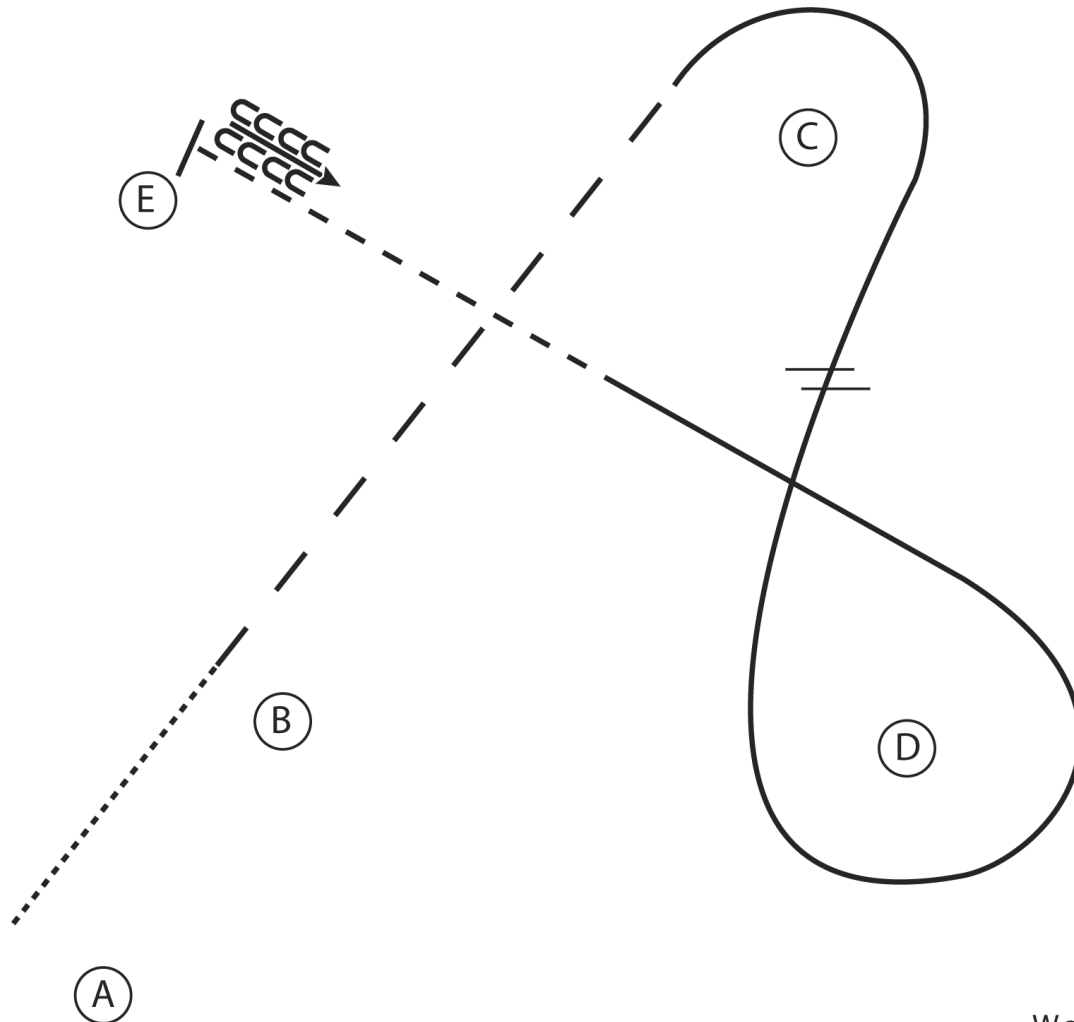

1. Walk A to B
2. At B extend the jog to C
3. At C lope a circle around C on the right lead
4. Between C and D perform a simple lead change
5. Lope a circle around D
6. Break to the jog when between D and E
7. At E stop and back 4 steps

Walk
Jog	-----
Extended Jog	-----
Lope	—————
Leg Yield	
Lead Change	↘
Back	←←←←
Marker	(B)
Sidepass	←←←←

[WH/2-11]

Pattern Provided by:

Emily Southard

2026 BVR Schooling Show

Class 23 Western Equitation 0-3 Years

Show Date: 04-25-2026

w w w . H o r s e S h o w P a t t e r n s . c o m

w w w . H o r s e S h o w P a t t e r n s . c o m

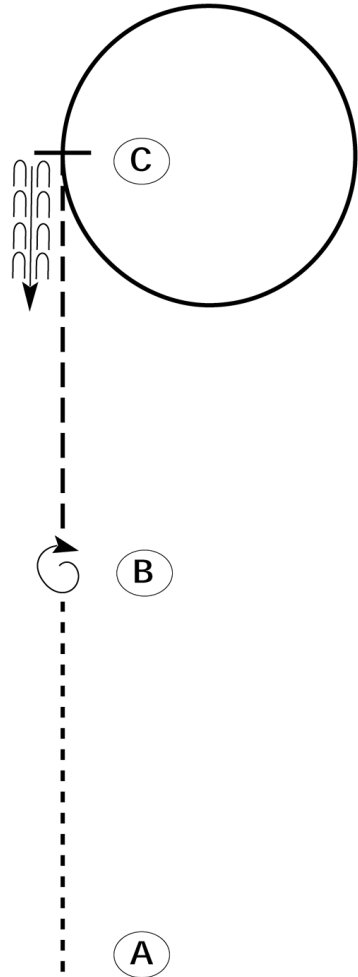

Be ready at A.

1. Walk from A to B.
2. Stop at B and perform a 360 degree turn to the right.
3. Jog to C.
4. Even with C, lope a circle to the right on the right lead.
5. Stop at C and back one horse length.

Follow the instructions of your ring steward.

Walk	-----
Jog	- - - - -
Extended Jog	- - - - -
Lope	—————
Leg Yield	
Lead Change	— / —
Back	← ← ← — — —
Marker	Ⓚ
Sidepass	← — — — →

[WH/1-47]

Pattern Provided by:

Emily Southard

2026 BVR Schooling Show

Class 25 Western Equitation Walk/Jog

Show Date: 04-25-2026

w w w . H o r s e S h o w P a t t e r n s . c o m

w w w . H o r s e S h o w P a t t e r n s . c o m

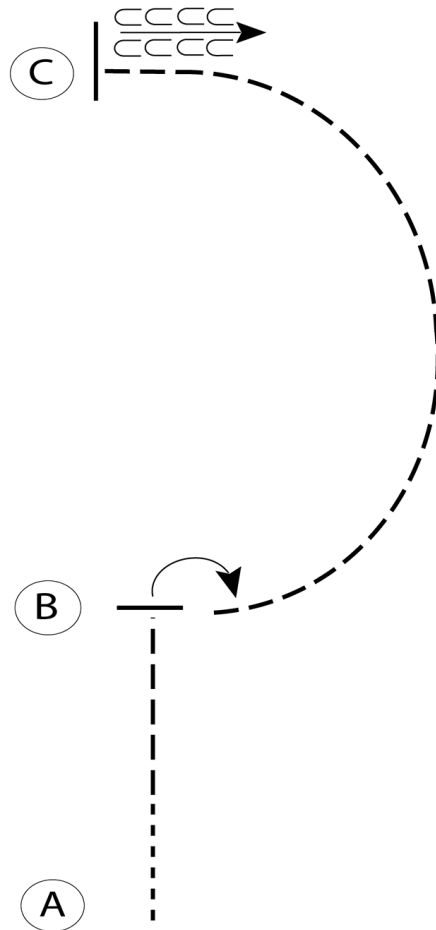

1. Be ready at A
2. Walk four steps from A.
3. Jog to B and stop.
4. Perform a 90 degree turn to the right on the hindquarters.
5. Jog a half circle to C.
6. At C stop and back four steps.

Walk	-----
Jog	- - - - -
Extended Jog	- - - - -
Lope	—————
Leg Yield	
Lead Change	— / —
Back	← C C C C
Marker	⊙ B
Sidepass	←-----→

[WH/WT-16]

Pattern Provided by:

Emily Southard

Class 27. Western Riding 4+ years showing

131. Pattern 1 – Level III and IV Western Riding

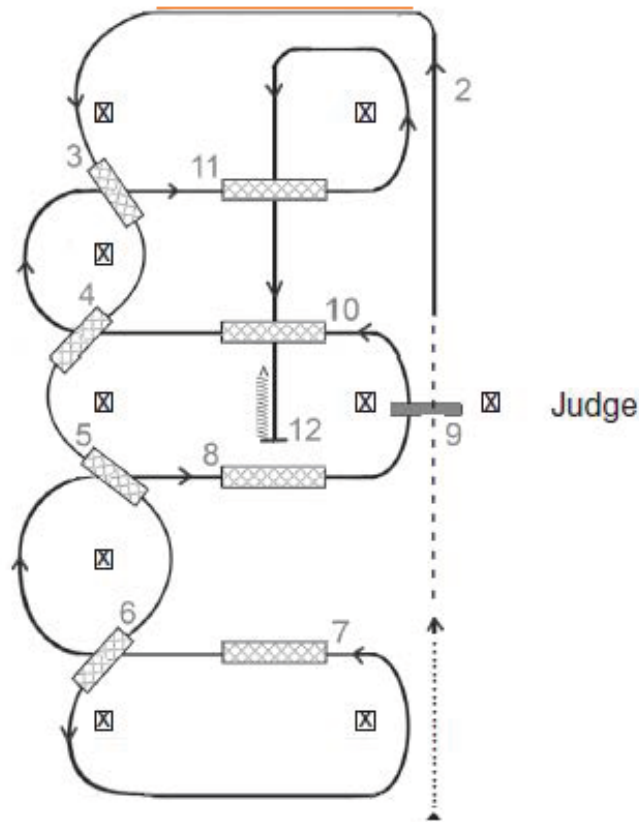

Walk: Lope: _____
 Back: //////////////// Jog: - - - - -
 Lead Changing Area: XXXXXXXXXX

Flying lead changes are required, simple lead changes to be penalized. See rules 118 and 124.B.9.

1. Walk & jog over log.
2. Transition to lope.
3. First line change.
4. Second line change.
5. Third line change.
6. Fourth line change, lope around the end of arena.
7. First crossing change.
8. Second crossing change.
9. Lope over log.
10. Third crossing change.
11. Fourth crossing change.
12. Lope up center, stop and back

Class 28. Western Riding 0-3 Years Showing

126. Pattern B – Level I Western Riding

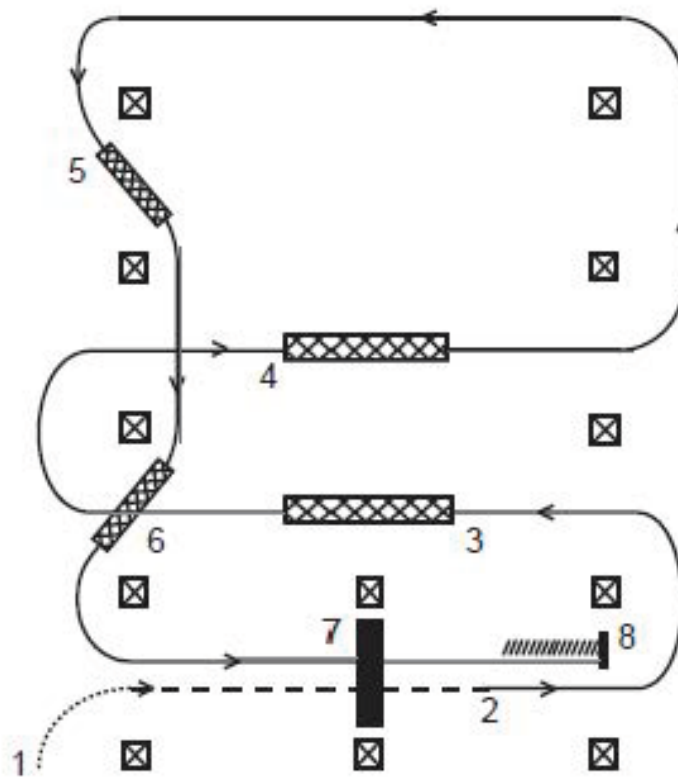

Walk: Lope: _____
Back: //////////////// Jog: - - - - -
Lead Changing Area: XXXXXXXXX

Simple lead changes are required, flying changes to be penalized. See rules 118 and 124.B.8.

1. Walk, transition to jog, jog over log.
2. Transition to lope.
3. First crossing change.
4. Second crossing change.
5. First line change.
6. Second line change.
7. Lope over log.
8. Stop and back.

2026 BVR Schooling Show

Class 29 Reining 4+ Years

Show Date: 04-25-2026

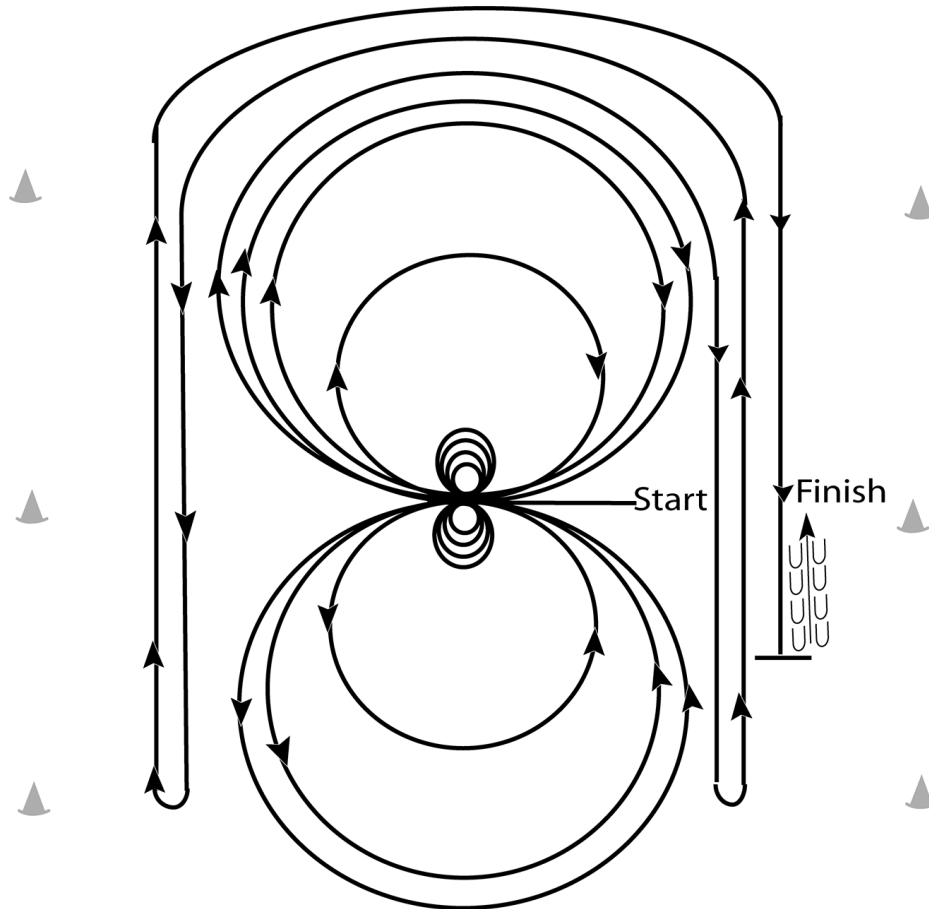

Horses may walk or trot to the center of the arena. Beginning at the center of the arena facing the left wall or fence.

1. Complete four spins to the left.
 2. Complete four spins to the right. Hesitate.
 3. Beginning on the right lead, complete three circles to the right: the first circle large and fast; the second circle small and slow; the third circle large and fast. Change leads at the center of the arena.
 4. Complete three circles to the left: the first circle large and fast; the second circle small and slow; the third circle large and fast. Change leads at the center of the arena.
 5. Begin a large fast circle to the right but do not close this circle. Run straight down the right side of the arena past the center marker and do a left rollback at least twenty feet (6.09m) from the wall or fence – no hesitation.
 6. Continue back around the previous circle but do not close this circle. Run down the left side of the arena past the center marker and do a right rollback at least twenty feet (6.09m) from the wall or fence – no hesitation.
 7. Continue back around the previous circle but do not close this circle. Run down the right side of the arena past the center marker and do a sliding stop at least twenty feet (6.09m) from the wall or fence. Back up at least ten feet (3m). Hesitate to demonstrate completion of the pattern.
- Rider may dismount and drop bridle to the designated judge.

[R/NRHAP-8]

Pattern Provided by:

Emily Southard

Class 30. Reining 0-3 Years Showing

164. Pattern A – Level I Reining

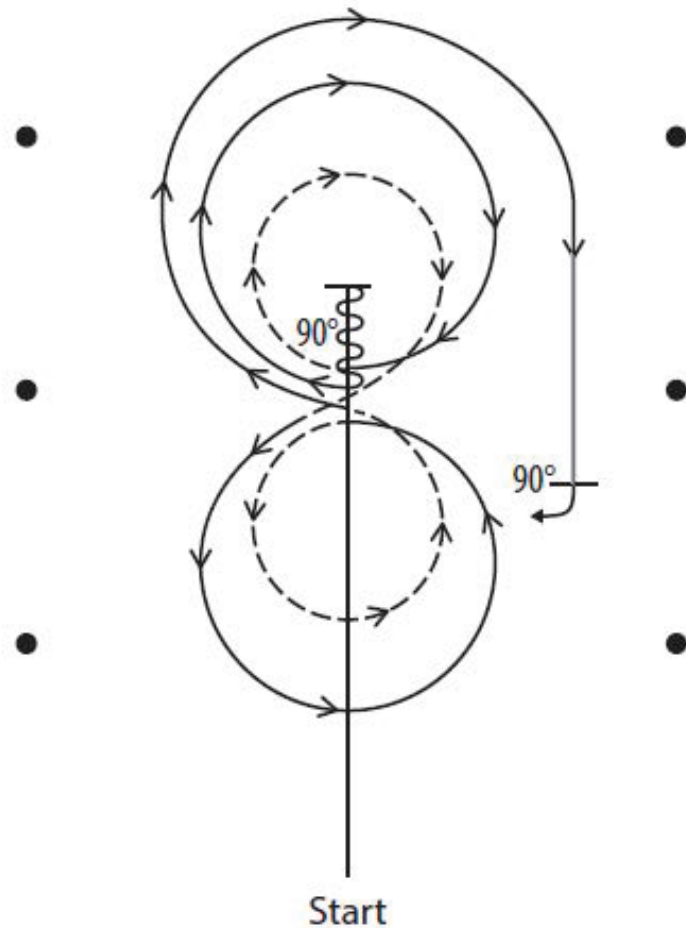

Back:  Jog:  Lope: 

Proper execution of this pattern requires Level I Advancement skills. All stops are balanced.

1. Lope at least ten feet past center marker. Stop & back up to the center, or at least ten feet.
2. 90 degree turn to the left, hesitate.
3. Lope large circle right.
4. Trot small circle right.
5. Lope large circle left.
6. Trot small circle left.
7. At center, pick up right lead, begin a large circle to the right but do not close this circle. Run straight down the right side of the arena staying at least twenty feet from the wall or fence past the center marker, stop.
8. 90 degree turn to the right.