

**2023 Boulder County Horse Judging Team  
Benefit Horse Show  
Saturday, July 22, 2023**



**Boulder County  
4-H Judging Team**

**PATTERNS**

**2023 Boulder County Horse Judging Team  
Benefit Horse Show  
Classes 2 & 4 English Equitation Open Adult & Level  
III & IV**

**J**

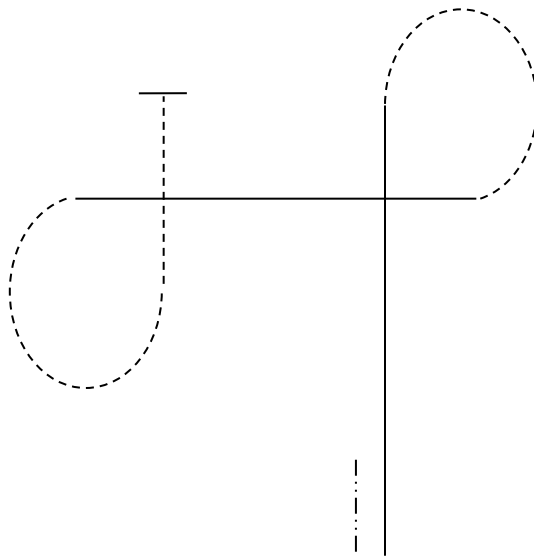

Be ready at start.  
Back 4 steps.  
Canter on the left lead  
down quarter line.  
Drop to a trot on the left  
diagonal and circle to  
the right.  
Canter on the right lead  
in a two-point position  
across the center.  
Drop to a sitting trot and  
circle to the left.  
Halt.  
Follow further  
instructions from judge.

**Pattern Legend**

- Walk      .....-.....
- Trot      - - - - -
- Canter    \_\_\_\_\_
- Back      ..-.-.-.-

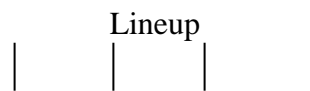

**Good Luck!**

**Judge: *Justine Dunlap-Truly***

**2023 Boulder County Horse Judging Team  
Benefit Horse Show  
Classes 3 & 5 English Equitation Level II & Open  
Youth**

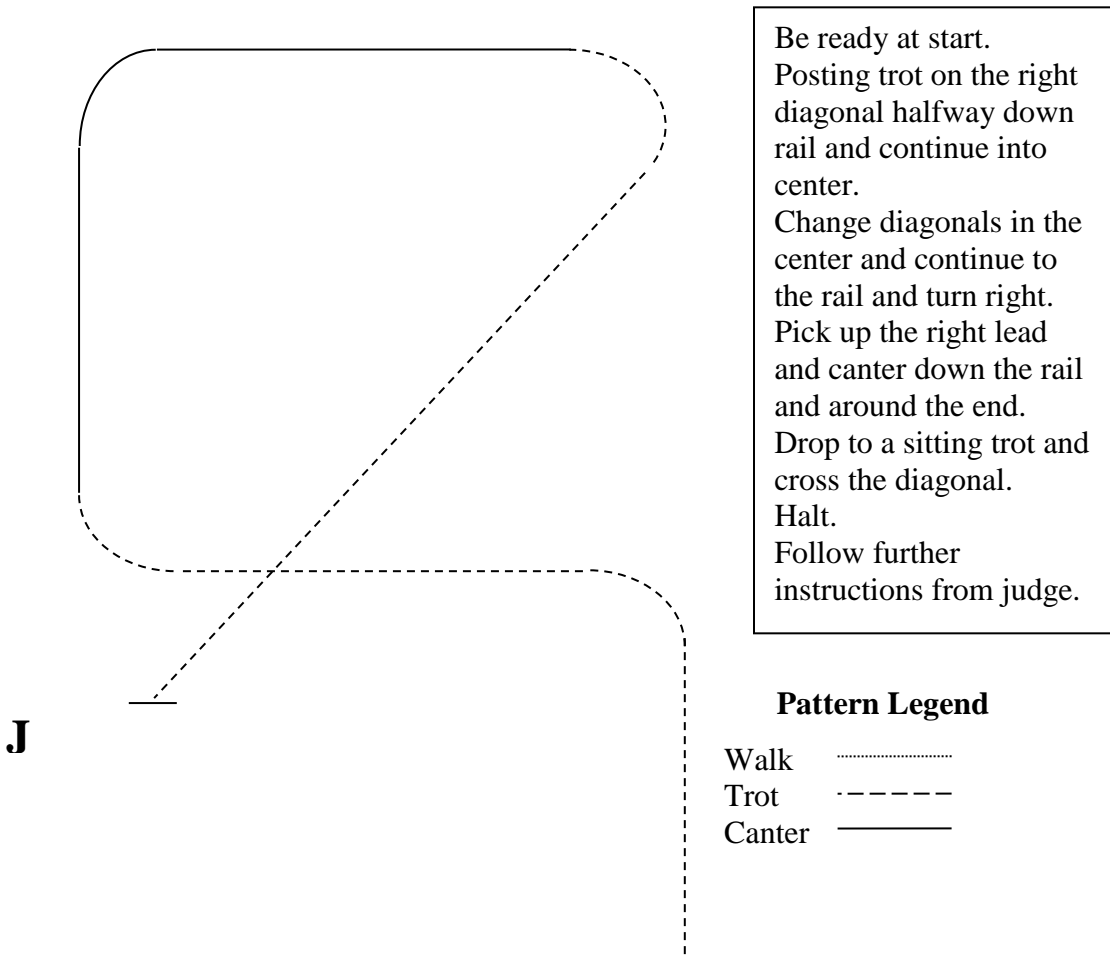

Be ready at start.  
Posting trot on the right diagonal halfway down rail and continue into center.  
Change diagonals in the center and continue to the rail and turn right.  
Pick up the right lead and canter down the rail and around the end.  
Drop to a sitting trot and cross the diagonal.  
Halt.  
Follow further instructions from judge.

**Pattern Legend**

- Walk    .....
- Trot    - - - - -
- Canter    \_\_\_\_\_

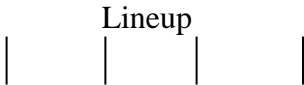

**Good Luck!**

**Judge: *Justine Dunlap-Truly***

**2023 Boulder County Horse Judging Team  
Benefit Horse Show  
Classes 6 & 7 English Equitation Level I & Unrated**

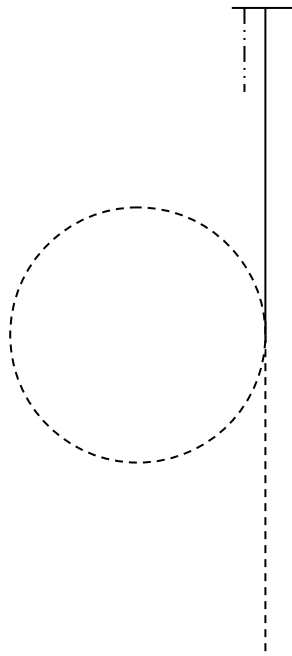

Be ready at start.  
Posting trot down  
centerline.  
At halfway, trot a circle  
to the left.  
At the conclusion of the  
circle, pick up the left  
lead and canter on  
centerline to end.  
Halt.  
Back 5 steps.  
Return to lineup.

**Pattern Legend**

- Walk ..... (dotted line)
- Trot - - - - - (dashed line)
- Canter \_\_\_\_\_ (solid line)
- Back ..-.-.-.- (dash-dot line)

Lineup

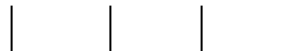

**Good Luck!**

**Judge: *Justine Dunlap-Truly***

# 2023 Boulder County Horse Judging Team Benefit Horse Show Class 13 English Control Open Adult

477. Pattern C – Level II English Control

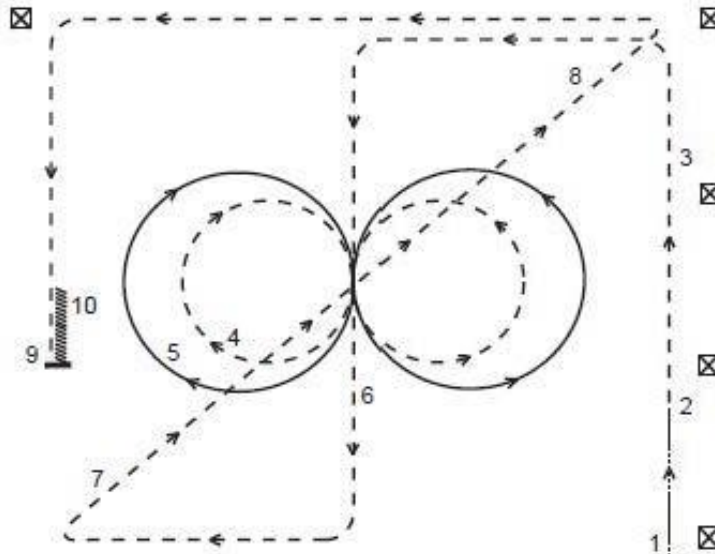

Walk: \_\_\_\_\_ Canter: \_\_\_\_\_  
Back: /////////////// Trot: - - - - -

1. Walk.
2. Sitting trot.
3. Working trot, rising.
4. Figure 8 at rising trot showing change of diagonal going to the right first.
5. Figure 8 at canter showing simple change of lead going to the right first.
6. Sitting trot.
7. Lengthened trot, rising demonstrating a change of diagonal while crossing center.
8. Working trot, sitting.
9. Halt.
10. Back.

Leave arena on a loose rein at the free walk.

Markers 30 feet to 50 feet apart. Suggested arena size 150 feet by 200 feet.

**Judge: *Justine Dunlap-Truly***

# 2023 Boulder County Horse Judging Team Benefit Horse Show Class 14 English Control Open Youth

475. Pattern A – Level I English Control

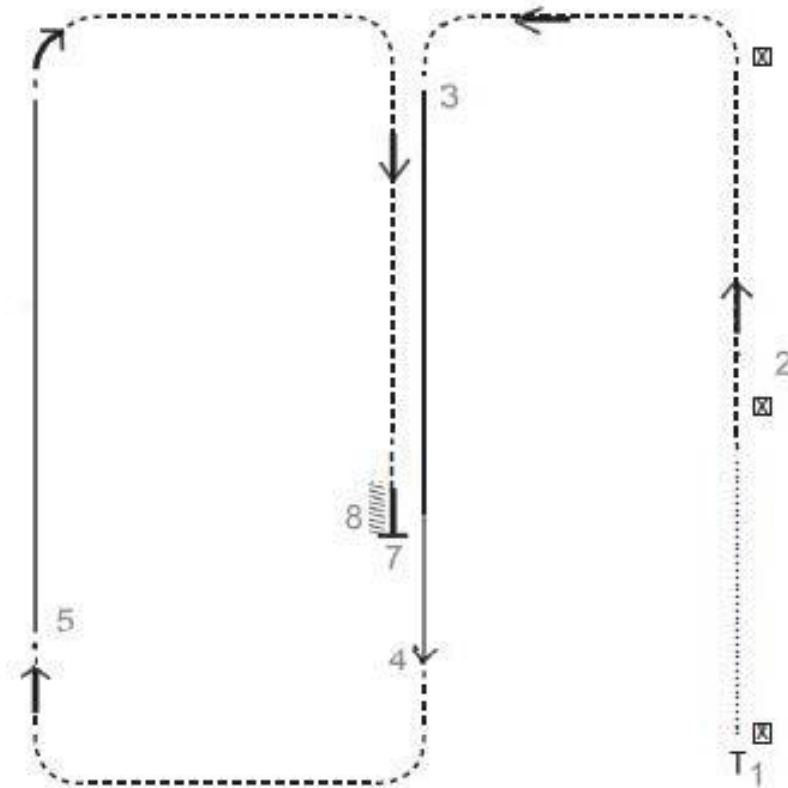

Walk: ..... Canter: \_\_\_\_\_  
 Back: //////////////// Trot: - - - - -

1. Walk.
2. Trot on the right diagonal.
3. Canter down center on the left lead.
4. Sitting Trot.
5. Canter on the right lead.
6. Posting trot on the left diagonal down the center.
7. Halt.
8. Back three steps.

Leave the arena on a loose rein at the free walk.

**Judge: *Justine Dunlap-Truly***

**2023 Boulder County Horse Judging Team  
Benefit Horse Show  
Classes 17 & 18 Showmanship Open Adult & Open  
Youth**

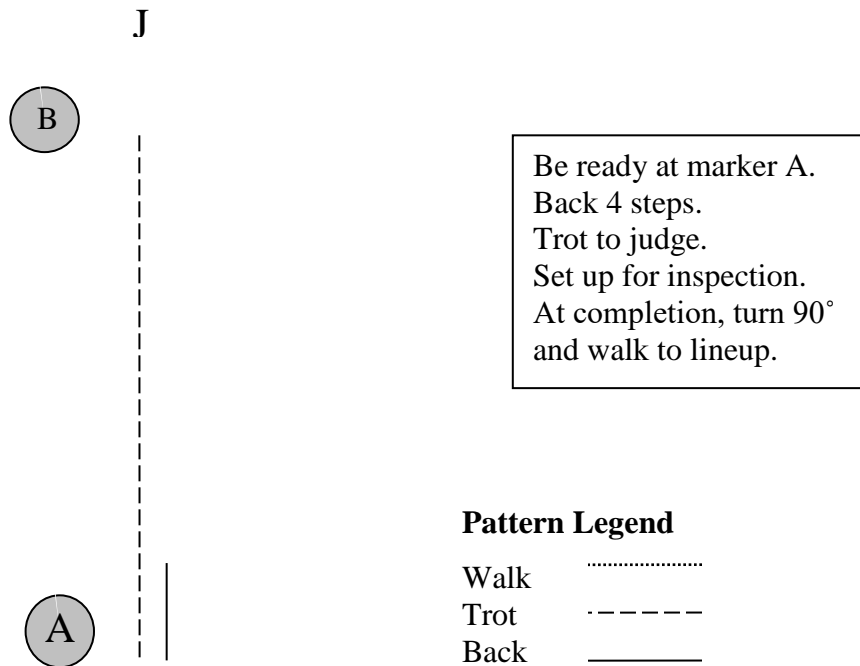

**Good Luck!**

**Judge: *Justine Dunlap-Truly***

**2023 Boulder County Horse Judging Team  
Benefit Horse Show  
Class 19 Showmanship Levels III & IV**

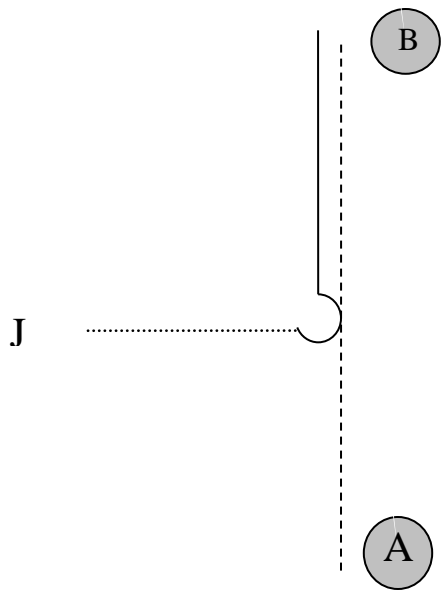

Be ready at marker A.  
Trot to marker B.  
Halt.  
Back.  
Execute a 270° pivot.  
Walk to Judge.  
Set up for inspection.  
At completion, turn 90°  
and walk to lineup.

**Pattern Legend**

Walk      .....  
Trot      - - - - -  
Back      \_\_\_\_\_

**Good Luck!**

**Judge: *Justine Dunlap-Truly***



**2023 Boulder County Horse Judging Team  
Benefit Horse Show  
Class 20 Showmanship Level II**

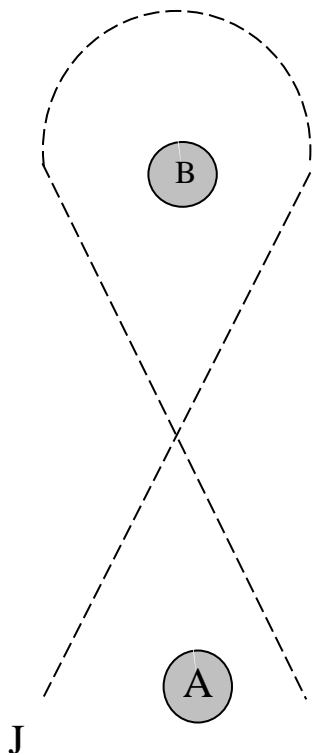

Be ready at marker A.  
Trot to and around  
marker B and to the  
other side of marker A.  
Set up for inspection.  
At completion, turn 90°  
and walk to lineup.

**Pattern Legend**

- Walk      .....
- Trot      - - - - -
- Back      \_\_\_\_\_

**Good Luck!**

**Judge: *Justine Dunlap-Truly***

**2023 Boulder County Horse Judging Team  
Benefit Horse Show  
Classes 21 & 22 Showmanship Level I, Unrated &  
Walk Trot**

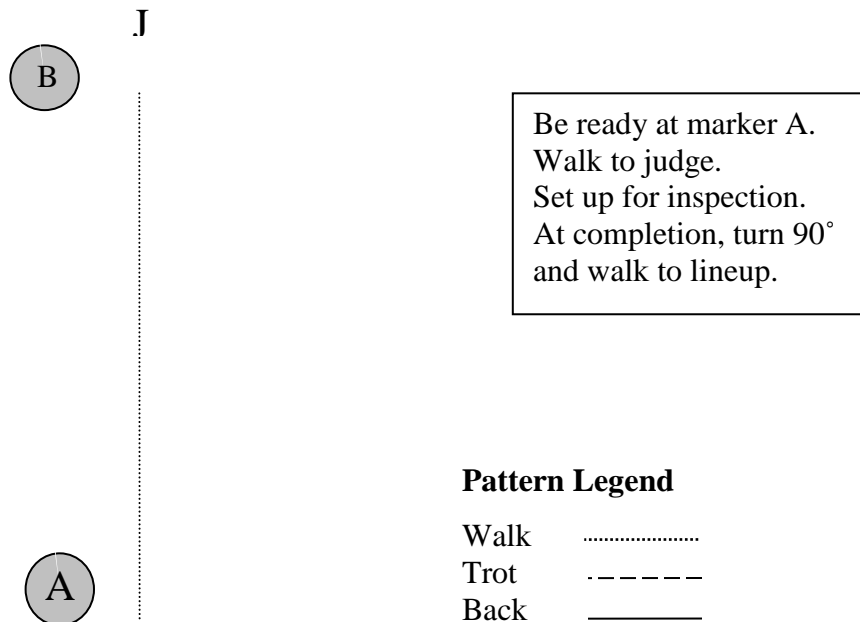

**Good Luck!**

**Judge: *Justine Dunlap-Truly***

**Boulder County 4-H Horse Judging Team  
Benefit Horse Show  
Classes 24 & 25 Western Horsemanship  
Open Adult & Open Youth**

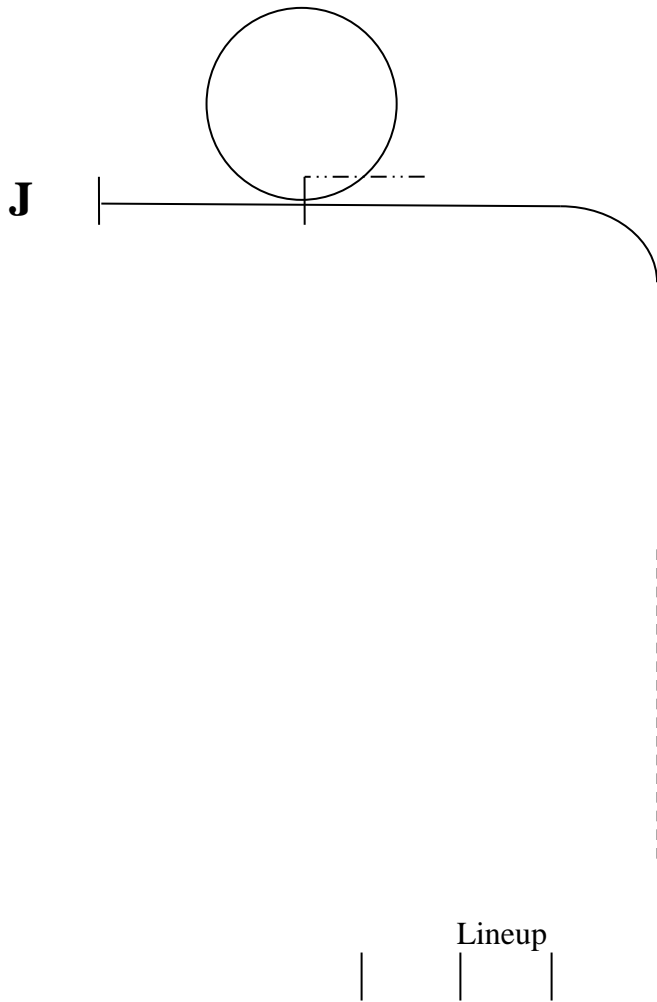

Be ready at start.  
 Jog a quarter of the way  
 down rail.  
 Pick up left lead.  
 Lope into center.  
 Halt.  
 Back 5 steps.  
 Lope a circle on the  
 right lead and continue  
 straight.  
 Halt at judge.  
 Follow further  
 instructions from judge.

**Pattern Legend**

- Walk ..... (dotted line)
- Jog - - - - - (dashed line)
- Lope \_\_\_\_\_ (solid line)
- Back - · - · - · (dash-dot line)

**Good Luck!**

**Judge: *Justine Dunlap-Truly***

**Boulder County 4-H Horse Judging Team  
Benefit Horse Show  
Class 26 Western Horsemanship  
4-H Levels III & IV**

Be ready at start.  
Walk 5 strides.  
Make a square corner to the left and pick up the jog.  
Perform a square corner and continue up the rail.  
Halfway down rail, halt.  
Pivot 360° on the hindquarters to the left.  
Drop stirrups.  
Follow further instructions from judge.

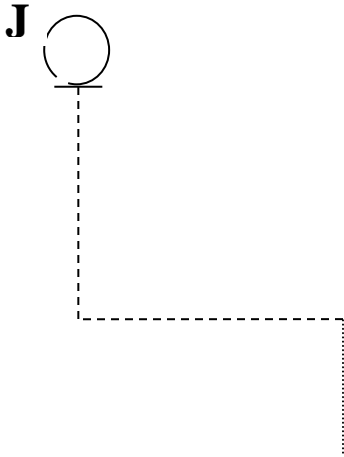

**Pattern Legend**

- Walk    ..... (dotted line)
- Jog     - - - - - (dashed line)
- Lope    \_\_\_\_\_ (solid line)

Lineup



**Good Luck!**

**Judge: *Justine Dunlap-Truly***

**Boulder County 4-H Horse Judging Team  
Benefit Horse Show  
Class 27 Western Horsemanship  
4-H Level II**

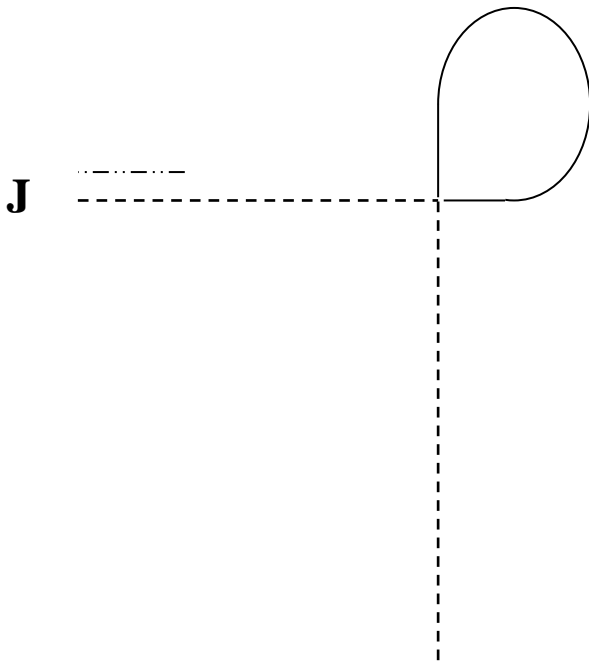

Be ready at start.  
Jog down centerline.  
Pick up the right lead  
and perform a tear drop.  
Jog across the center  
toward the judge.  
Back 5 steps.  
Follow further  
instructions from judge.

**Pattern Legend**

Walk .....  
Jog - - - - -  
Lope \_\_\_\_\_  
Back - . . . . .

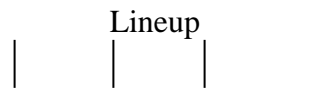

**Good Luck!**

**Judge: *Justine Dunlap-Truly***

**Boulder County 4-H Horse Judging Team  
Benefit Horse Show  
Classes 28 & 29 Western Horsemanship  
4-H Level I & Unrated**

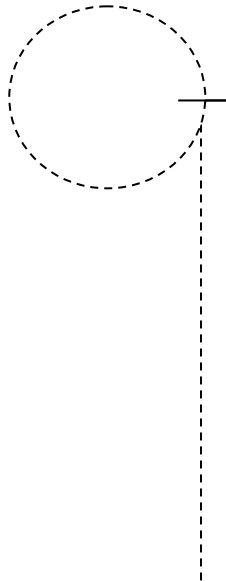

Be ready at start.  
Jog halfway down rail.  
Without stopping,  
perform a circle to the  
left.  
Halt.  
Return to lineup.

**Pattern Legend**

Walk .....  
Jog - - - - -  
Lope \_\_\_\_\_

Lineup



**Good Luck!**

**Judge: *Justine Dunlap-Truly***

# 2023 Boulder County Horse Judging Team Benefit Horse Show Class 36 Ranch Riding Open Adult

370. Pattern 15 – Ranch Riding

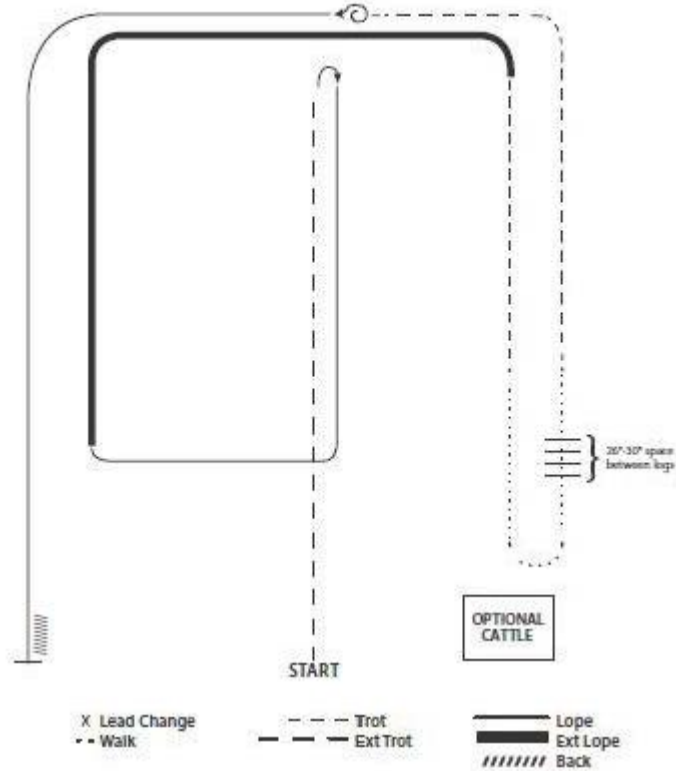

1. Extended trot
2. Stop, rollback right
3. Lope right lead
4. Extended lope (right lead)
5. Trot
6. Walk
7. Walk over logs
8. Walk
9. Trot
10. Stop, 360 left
11. Lope left lead
12. Stop and back

**Note:** The drawn description of this pattern is only intended for the general depiction of the pattern. Exhibitors should utilize the arena space to best exhibit their horses.

**Judge: *Justine Dunlap-Truly***

# 2023 Boulder County Horse Judging Team Benefit Horse Show Class 37 Ranch Riding Open Youth

359. Pattern C – Level I and II Ranch Riding

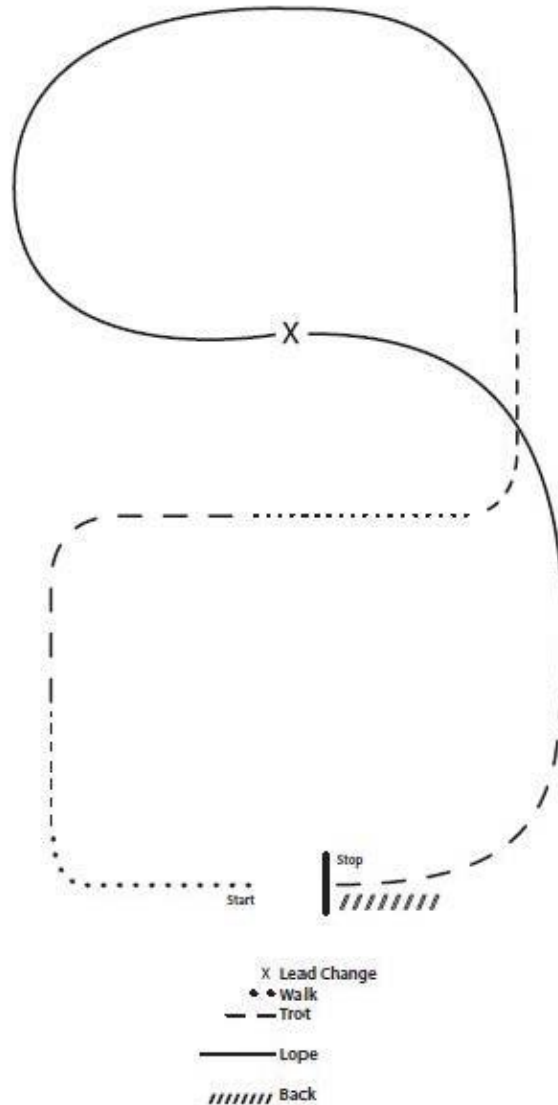

1. Walk to the left around corner of the arena
2. Trot alongside of the arena and around the corner to center
3. Walk
4. Trot
5. Lope left lead
6. Simple lead change
7. Lope on right lead
8. Trot
9. Stop and back

**Judge: *Justine Dunlap-Truly***



# 2023 Boulder County Horse Judging Team Benefit Horse Show Class 38 Western Riding Open Adult

134. Pattern 4 – Level III and IV Western Riding

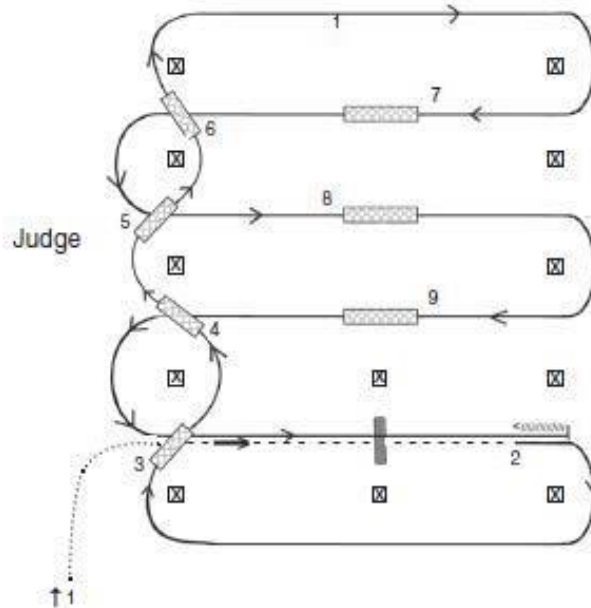

Walk: ..... Lope: \_\_\_\_\_  
 Back: //////////////// Jog: - - - - -  
 Lead Changing Area: XXXXXXXXX

Flying lead changes are required, simple lead changes to be penalized. See rules 118 and 124.B.9.

1. Walk, transition to jog, jog over log.
2. Transition to lope.
3. First line change.
4. Second line change.
5. Third line change.
6. Fourth line change.
7. First crossing change.
8. Second crossing change.
9. Third crossing change.
10. Lope over log
11. Stop & back.

135.-149. – NOT ASSIGNED

**Judge: *Justine Dunlap-Truly***

# 2023 Boulder County Horse Judging Team Benefit Horse Show Class 39 Western Riding Open Youth

127. Pattern C – Level I Western Riding

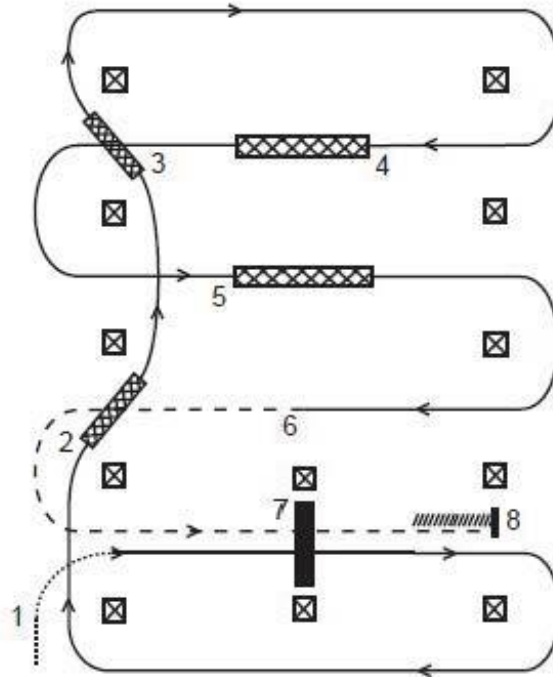

Walk: ..... Lope: \_\_\_\_\_  
 Back: //////////////// Jog: - - - - -  
 Lead Changing Area: XXXXXXXXX

Simple lead changes are required, flying changes to be penalized. See rules 118 and 124.B.8.

1. Walk, transition to lope, lope over log.
2. First line change.
3. Second line change.
4. First crossing change.
5. Second crossing change.
6. Transition to jog.
7. Jog over log.
8. Stop and back.

This pattern could be used for level 1 when choosing Western Riding Pattern Number 4.

**Judge: *Justine Dunlap-Truly***

# 2023 Boulder County Horse Judging Team Benefit Horse Show Class 40 Reining Open Adult

181. Pattern 5 – Level III and IV Reining (NRHA Pattern 7)

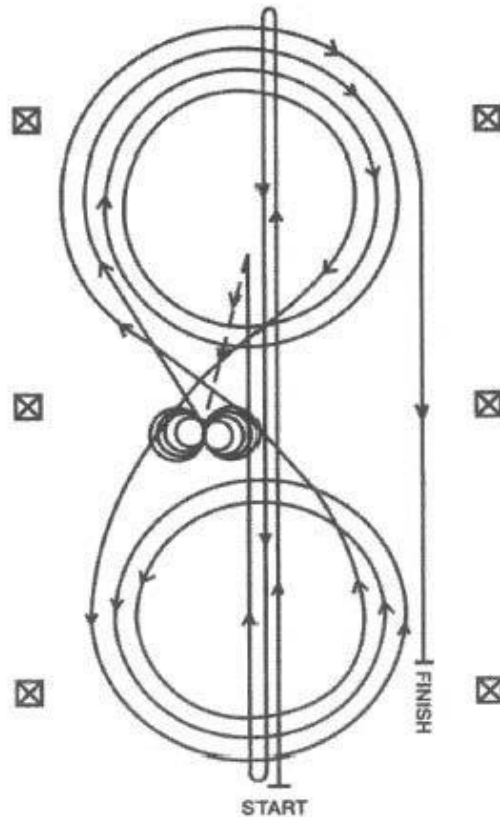

1. Run at speed to the far end of the arena past the end marker and do a left rollback – no hesitation.
2. Run to the opposite end of the arena past the end marker and do a right rollback – no hesitation.
3. Run past the center marker and do a sliding stop. Back up to the center of the arena or at least ten feet. Hesitate.
4. Complete four spins to the right. Hesitate.
5. Complete four and one-quarter spins to the left so that horse is facing left wall or fence. Hesitate.
6. Beginning on the right lead, complete three circles to the right: the first two circles large fast; the third circle small and slow. Change leads at the center of the arena.
7. Complete three circles to the left: the first two circles large and fast; the third circle small and slow. Change leads at the center of the arena.
8. Begin a large fast circle to the right but do not close this circle. Run straight down the right side of the arena past the center marker and do a sliding stop at least twenty feet from the wall or fence. Hesitate to demonstrate completion of the pattern.

Rider must drop bridle to the designated judge.

**Judge: *Justine Dunlap-Truly***

# 2023 Boulder County Horse Judging Team Benefit Horse Show Class 41 Reining Open Youth

172. Pattern I - Level II

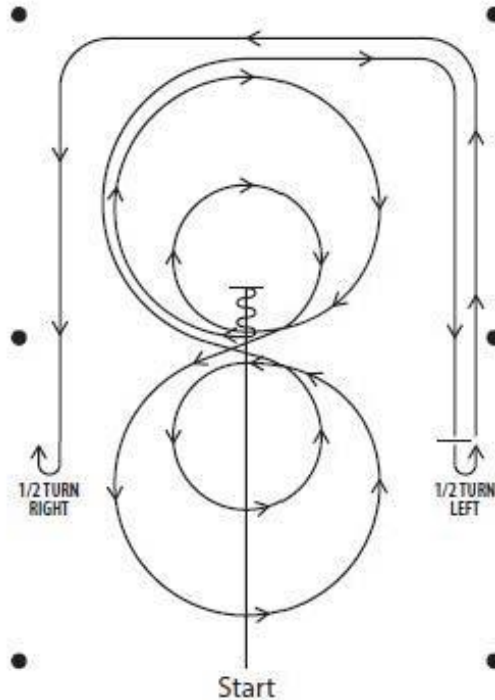

Back:  Jog:  Lope: 

Proper execution of this pattern requires Level II advancement skills. All stops are balanced.

1. Start at end of arena. Run down middle past center marker to a balanced stop.
2. Back at least ten feet to center. 90 degree turn to the left.
3. Pickup right lead, large fast circle, small slow circle.
4. Simple lead change to left, large fast circle, small slow circle.
5. Simple lead change to right, do not close this circle.
6. Run around end of arena and down the side (approximately 20 feet from fence) past center marker and come to a balanced stop.
7. Turn 180 degrees on the haunches to the left.
8. Continue back down side and end of arena to other side (approximately 20 feet from fence) go past center marker and come to a balanced stop.
9. Turn 180 degrees on the haunches to the right. Hesitate to complete pattern.

**Judge: *Justine Dunlap-Truly***

**2023 Boulder County Horse Judging Team  
Benefit Horse Show  
Class 42 Trail In-Hand**

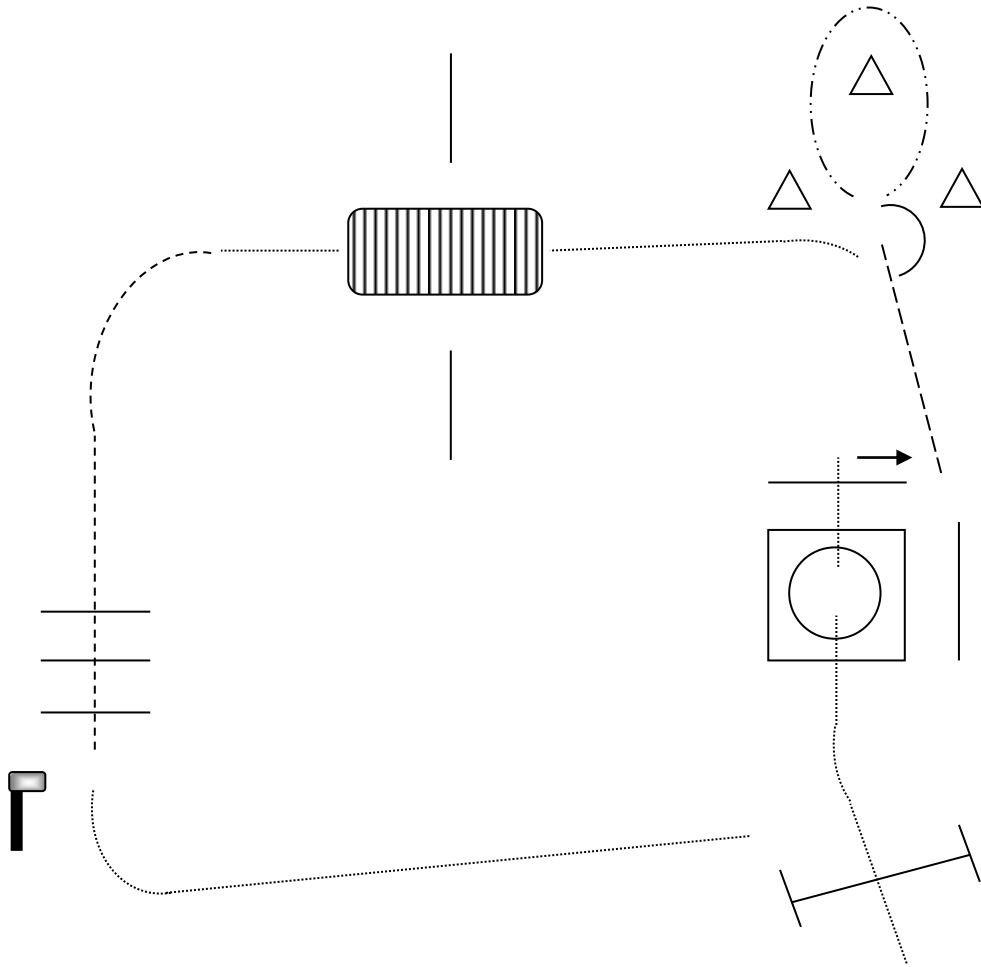

**Pattern Legend**

Walk .....  
Trot .....  
Back - . - . - .

Be ready at start. Work gate. Walk into box. Perform a 360° turn to the right. Begin to walk out of box and stop with hind feet in the slot. Sidepass right until clear of pole. Trot to cones. Halt. Perform a 180° turn to the right. Back as shown, either direction, around top cone. Walk to and over bridge. Trot to and over poles and up to mailbox. Halt. Open and close mailbox. Exit at a walk.

**2023 Boulder County Horse Judging Team  
Benefit Horse Show  
Class 43 English Trail**

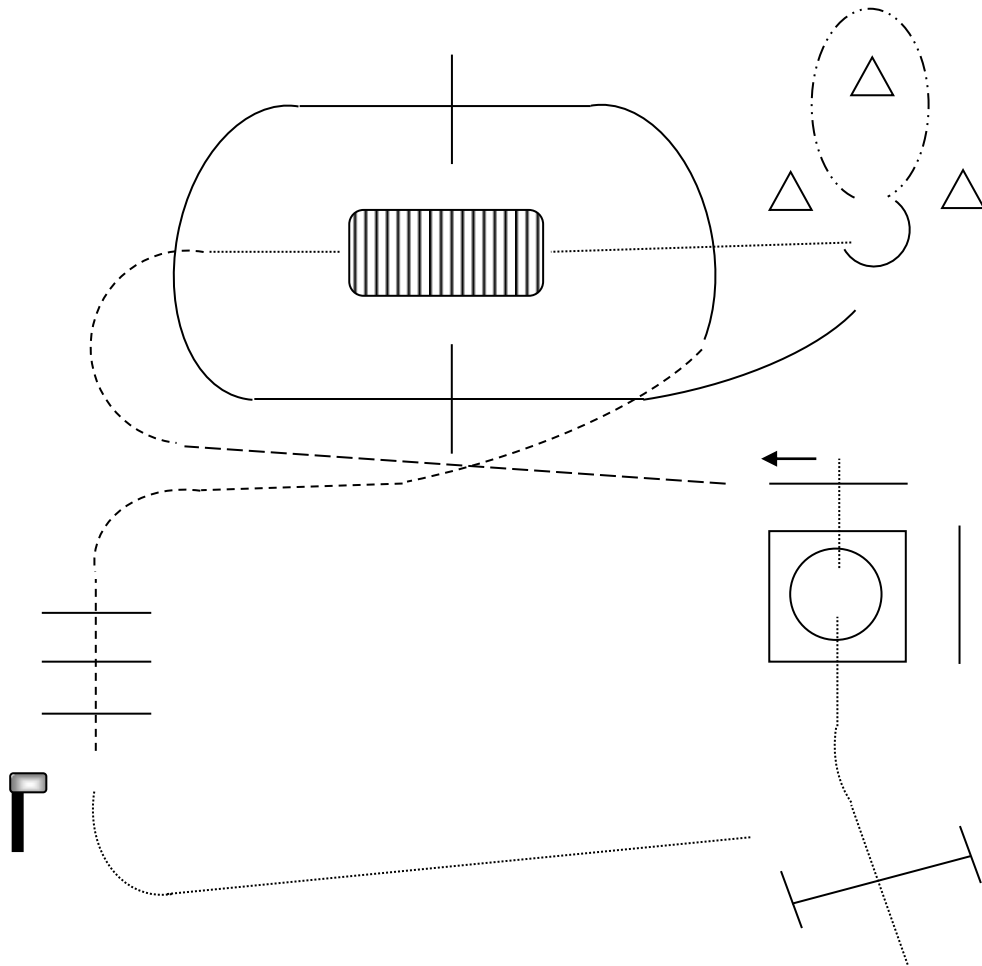

**Pattern Legend**

- Walk      .....
- Trot      - - - - -
- Canter    \_\_\_\_\_
- Back      - . - . - .

Be ready at start. Work right hand gate. Walk into box. Perform a 360° turn to the left. Begin to walk out of box and stop with hind feet in the slot. Sidepass left until clear of pole. Trot to far side of bridge. Walk to and over bridge. Walk to cones. Turn and back thru cones, either direction, to circle top cone. Pick up right lead and canter over poles around bridge as shown. Trot to and over poles and up to mailbox. Halt. Open and close mailbox. Exit at a walk.

**2023 Boulder County Horse Judging Team  
Benefit Horse Show  
Classes 44 & 45 Western Trail Open Adult & Youth**

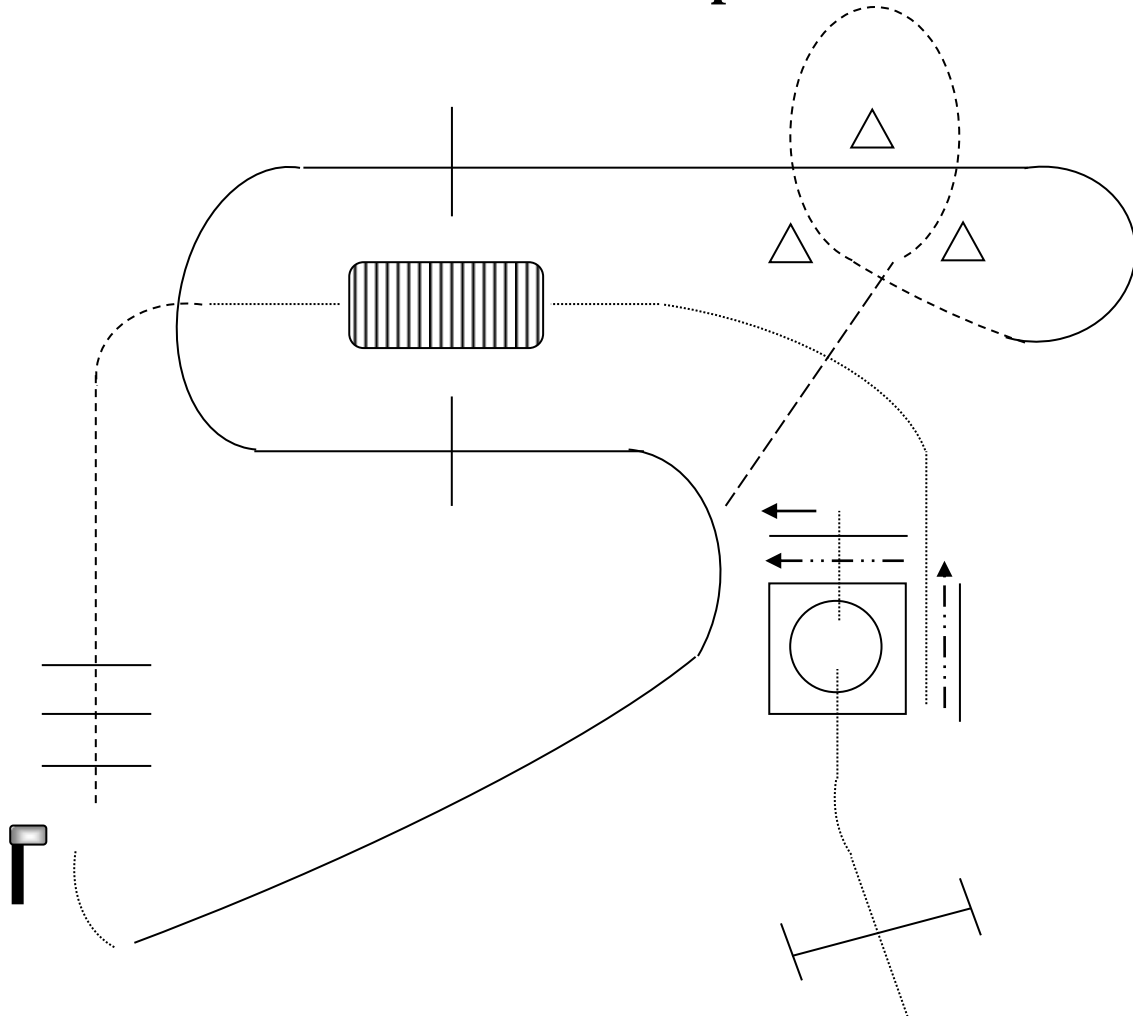

**Pattern Legend**

- Walk     .....
- Trot     - - - - -
- Canter   —————
- Back     - · - · - · -

Be ready at start. Work right hand gate. Walk into box. Perform a 360° turn to the left. Begin to walk out of box and stop with hind feet in the slot. Sidepass left until clear of pole. Jog cones as shown. Pick up left lead and lope poles on sides of bridge as shown. Change leads and lope to mailbox. Walk to, open and close mailbox. Jog over poles and toward bridge. Walk to and over bridge. Walk into chute. Back L. Halt to show completion and walk to exit.

**2023 Boulder County Horse Judging Team  
Benefit Horse Show  
Class 46 Western Trail Walk/Jog**

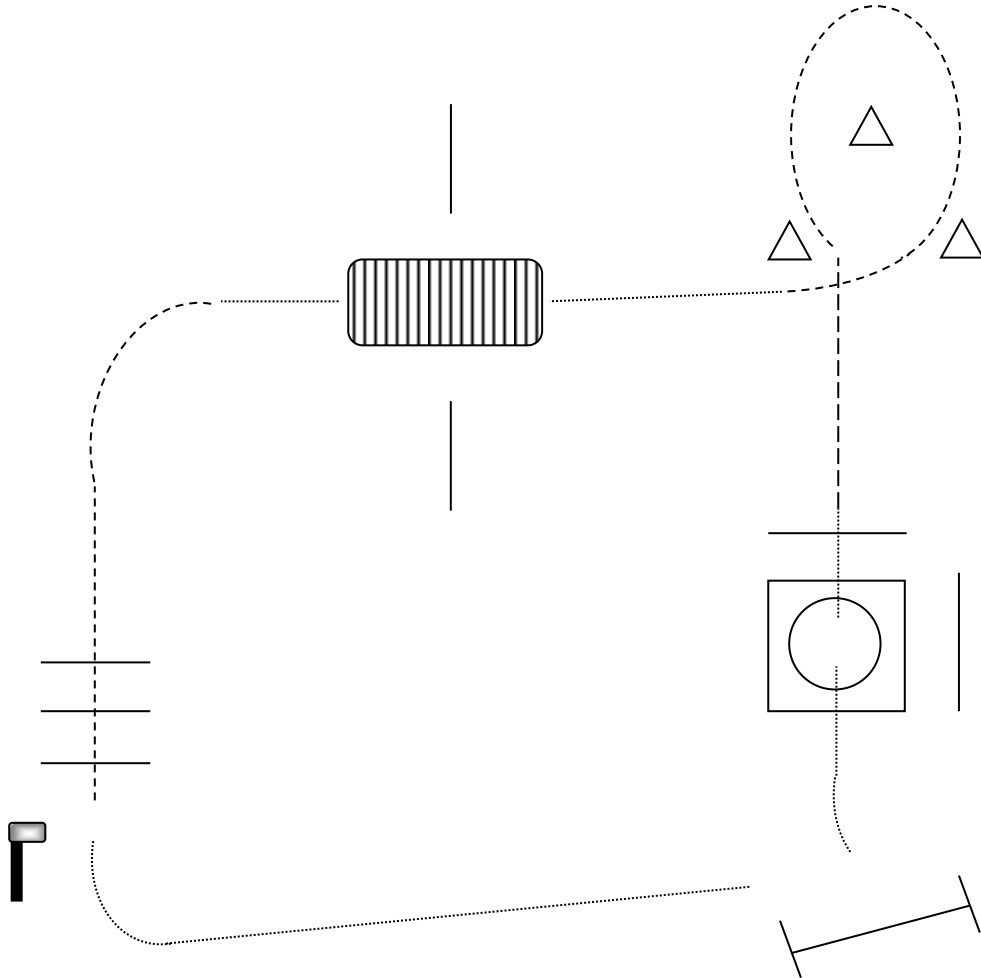

**Pattern Legend**

- Walk      .....
- Trot      - - - - -
- Back      ······

Be ready at start. Walk into box. Perform a 360° turn either direction. Walk out of box and over pole. Jog to and around cones as shown. Walk to and over bridge. Jog to and over poles and up to mailbox. Halt. Open and close mailbox. Walk to exit.